



INTERNATIONAL
ENERGY AGENCY



Energy Statistics MANUAL



INTERNATIONAL ENERGY AGENCY

9, rue de la Fédération,
75739 Paris Cedex 15, France

The International Energy Agency (IEA) is an autonomous body which was established in November 1974 within the framework of the Organisation for Economic Co-operation and Development (OECD) to implement an international energy programme.

It carries out a comprehensive programme of energy co-operation among twenty-six* of the OECD's thirty Member countries. The basic aims of the IEA are:

- to maintain and improve systems for coping with oil supply disruptions;
- to promote rational energy policies in a global context through co-operative relations with non-member countries, industry and international organisations;
- to operate a permanent information system on the international oil market;
- to improve the world's energy supply and demand structure by developing alternative energy sources and increasing the efficiency of energy use;
- to assist in the integration of environmental and energy policies.

* *IEA Member countries: Australia, Austria, Belgium, Canada, the Czech Republic, Denmark, Finland, France, Germany, Greece, Hungary, Ireland, Italy, Japan, the Republic of Korea, Luxembourg, the Netherlands, New Zealand, Norway, Portugal, Spain, Sweden, Switzerland, Turkey, the United Kingdom, the United States. The European Commission also takes part in the work of the IEA.*

ORGANISATION FOR ECONOMIC CO-OPERATION AND DEVELOPMENT

Pursuant to Article 1 of the Convention signed in Paris on 14th December 1960, and which came into force on 30th September 1961, the Organisation for Economic Co-operation and Development (OECD) shall promote policies designed:

- to achieve the highest sustainable economic growth and employment and a rising standard of living in Member countries, while maintaining financial stability, and thus to contribute to the development of the world economy;
- to contribute to sound economic expansion in Member as well as non-member countries in the process of economic development; and
- to contribute to the expansion of world trade on a multilateral, non-discriminatory basis in accordance with international obligations.

The original Member countries of the OECD are Austria, Belgium, Canada, Denmark, France, Germany, Greece, Iceland, Ireland, Italy, Luxembourg, the Netherlands, Norway, Portugal, Spain, Sweden, Switzerland, Turkey, the United Kingdom and the United States. The following countries became Members subsequently through accession at the dates indicated hereafter: Japan (28th April 1964), Finland (28th January 1969), Australia (7th June 1971), New Zealand (29th May 1973), Mexico (18th May 1994), the Czech Republic (21st December 1995), Hungary (7th May 1996), Poland (22nd November 1996), the Republic of Korea (12th December 1996) and Slovakia (28th September 2000). The Commission of the European Communities takes part in the work of the OECD (Article 13 of the OECD Convention).

EUROSTAT, L - 2920 Luxembourg

Eurostat is the Statistical Office of the European Communities. Its task is to provide the European Union with statistics, at a European level, that allow comparisons to be made between countries and regions. Eurostat consolidates and harmonises the data collected by the Member States. To ensure that the vast quantity of accessible data is made widely available and to help each user make proper use of the information, Eurostat has set up a publications and services programme. This programme makes a clear distinction between general and specialist users and particular collections have been developed for these different groups. The collections Press releases, Statistics in focus, Panorama of the European Union, Pocketbooks and Catalogues are aimed at general users. They give immediate key information through analyses, tables, graphs and maps. The collections Methods and nomenclatures and Detailed tables suit the needs of the specialist who is prepared to spend more time analysing and using very detailed information and tables. As part of the new programme, Eurostat has developed its web site. It includes a broad range of online information on Eurostat products and services, newsletters, catalogues, online publications and indicators on the euro zone.

© OECD/IEA, 2004

Applications for permission to reproduce or translate all or part of this publication should be made to:
Head of Publications Service, OECD/IEA - 2, rue André-Pascal, 75775 Paris Cedex 16, France
or 9, rue de la Fédération, 75739 Paris Cedex 15, France.

Foreword

Detailed, complete, timely and reliable statistics are essential to monitor the energy situation at a country level as well as at an international level. Energy statistics on supply, trade, stocks, transformation and demand are indeed the basis for any sound energy policy decision.

For instance, the market of oil – which is the largest traded commodity worldwide – needs to be closely monitored in order for all market players to know at any time what is produced, traded, stocked and consumed and by whom.

In view of the role and importance of energy in world development, one would expect that basic energy information to be readily available and reliable. This is not always the case and one can even observe a decline in the quality, coverage and timeliness of energy statistics over the last few years.

There are several reasons behind the decline of quality in energy statistics, including liberalisation of the market, additional data requests, budget cuts and diminishing expertise. The liberalisation of the energy markets, for instance, has had a double impact on statistics. First, where statisticians in the past could obtain detailed information on one fuel (gas or electricity) from a single national utility company, they now have to survey tens, if not hundreds, of companies to have a comprehensive view of a sector. Secondly, a competitive market often leads to confidentiality issues that add to the difficulty of collecting basic information.

Additional data have been requested from energy statistics offices over recent years. They include a large spectrum of information ranging from statistics on renewables to indicators on energy efficiency and data on greenhouse gas emissions. This additional workload occurred at a time when statistics offices in many countries were experiencing a reduction in their resources. Sometimes the reduction has been dramatic and the number of staff cut by half.

There is no one miracle solution to stop the current erosion in data quality, coverage and timeliness. However, it is clear that statistics and statisticians should be fully integrated in the energy policy decision-making process of a country.

Knowing the importance of a sound energy information system, the International Energy Agency has embarked upon a programme of actions to reverse the current trends by developing tools to facilitate the preparation and delivery of reliable statistics, thus raising the profile of energy statistics in countries.

Strengthening the expertise and experience of energy statisticians, and rebuilding corporate memory are key priorities. This is the reason why the *International Energy Agency*, in co-operation with the *Statistical Office of the European Communities* (Eurostat), has prepared this *Energy Statistics Manual*. The *Manual* will help newcomers in the energy statistics field to have a better grasp of definitions, units and methodology.

The current *Manual* can be used by energy statisticians and analysts of all countries, although it includes in a few places references to the joint IEA/OECD-Eurostat-UNECE questionnaires in order to facilitate the completion of these questionnaires. Moreover, it will soon be complemented by a more general energy statistics guide which should be seen as a first step towards a worldwide harmonisation of energy statistics.

Transparency is high on the agenda of energy ministers. It starts with transparent and reliable data. It is our sincere hope that this *Manual* will contribute to improve the understanding of definitions, facilitate the use of units and conversion factors, clarify methodology and, at the end of the day, improve transparency.

Claude Mandil

Executive Director

Acknowledgements

This manual was prepared by the *Energy Statistics Division* (ESD) of the *International Energy Agency* (IEA) in co-operation with the *Statistical Office of the European Communities* (Eurostat).

The manual was designed and managed by Jean-Yves Garnier, Head of the *Energy Statistics Division* of the IEA. Other members of ESD who were responsible for bringing this manual to completion include: Larry Metzroth (coal, electricity, renewables), Mieke Reece (oil and natural gas), Karen Tréanton (fundamentals and energy balances), Jason Elliott, Bruno Castellano, Cintia Gavay, Vladimir Kubecek, Jan Kuchta and Olivier Lavagne d'Ortigue. Peter Tavoularis, Nikolaos Roubanis and Pekka Loesonen from Eurostat also contributed to the preparation of the manual.

The manual greatly benefited from the work done by Tim Simmons, consultant, who put his expertise and experience into preparing a comprehensive draft.

Special thanks are given to: Sharon Burghgraeve for the enormous amount of work and the patience she displayed in formatting, Bertrand Sadin for preparing so well the graphs and schematics, Corinne Hayworth for the overall layout of the book and making a technical subject quite attractive, and Viviane Consoli for her sharp eye in the final editing.

Table of Contents

Foreword	3
Acknowledgements	5
Introduction	13

1 Fundamentals **17**

1. Introduction	17
2. What do People Mean by “Fuels” and “Energy”?	17
3. What are Primary and Secondary Energy Commodities?	18
4. What are Fossil Fuels and Renewable Energy Forms?	18
5. How to Measure Quantities and Heating Values?	19
6. What is the Difference between Gross and Net Calorific Values?	20
7. What is a “Commodity Flow”?	20
8. What are the Main Flows Considered in Energy Statistics?	22
9. How are Energy Data Presented?	30

2 Electricity and Heat **39**

1. What are Electricity and Heat?	39
2. What Units are Used to Express Electricity and Heat?	41
3. How to Make the Conversion from Volume and Mass to Energy?	42
4. Electricity and Heat Flows	42
5. Electricity and Heat Supply	45
6. Electricity and Heat Consumption	50
7. Additional Requirements for the Joint Questionnaire on Electricity and Heat	52

3 Natural Gas **55**

1. What is Natural Gas?	55
2. What Units are Used to Express Natural Gas?	56
3. How to Make the Conversion from Volume to Energy?	57
4. Natural Gas Flows	58
5. Natural Gas Supply	60
6. Natural Gas Consumption	64
7. Additional Requirements for the Joint Questionnaire on Natural Gas	68

4 Oil

69

1. What is Oil? 69
2. What Units are Used to Express Oil? 71
3. How to Make the Conversion from Volume to Mass? 72
4. Oil Flows 73
5. Oil Supply 75
6. Oil Consumption 85
7. Additional Requirements for the Joint Questionnaire on Oil 90

5 Solid Fossil Fuels and Manufactured Gases

93

1. What Are Solid Fossil Fuels and Manufactured Gases? 93
2. What Units are Used to Express Solid Fossil Fuels and Manufactured Gases? 95
3. How to Make the Conversion from Mass and Volume to Energy? 97
4. Coal Flows 98
5. Coal Supply 100
6. Coal Consumption 103
7. Additional Requirements for the Joint Questionnaire on Coal 109

6 Renewables and Waste

115

1. What are Renewables and Waste? 115
2. What Units are Used to Express Renewables and Waste? 117
3. How to Make the Conversion from Volume and Mass to Energy? 118
4. Renewables and Waste Flows 119
5. Renewables and Waste Supply 122
6. Renewables and Waste Consumption 127
7. Additional Requirements for the Joint Questionnaire on Renewables and Waste 131

7 Energy Balances

135

1. Why Make Balances? 135
2. Commodity Balances 135
3. Energy Balances 136
4. Differences between the Energy Balances of Eurostat and the IEA 140

A Annexes **145**

Annex 1: Fuel Conversion and Energy Production Processes **145**

1. Electricity and Heat Generation 145
2. Petroleum Product Manufacture 155
3. Manufacture of Coal-derived Fuels 157
4. Natural Gas 162

Annex 2: Fuel Characteristics **167**

1. Solid Fossil Fuels and Derived Gases 167
2. Crude Oil and Products 169
3. Natural Gas 173
4. Biofuels 173

Annex 3: Units and Conversion Equivalents **177**

1. Introduction 177
2. Units and their Interrelationships 177
3. Decimal System Prefixes 177
4. Conversion Equivalents 178
5. Typical Calorific Values 180

G Glossary **185**

1. Definitions of Fuels 185
2. List of Abbreviations 192

List of Figures

Figure 1.1	Terminology for Energy Commodities	18
Figure 1.2	Main Commodity Flows	21
Figure 1.3	Commodity Balance Structure	30
Figure 1.4	Sources of Supply	31
Figure 1.5	Industry	33
Figure 1.6	Other Sectors	34
Figure 1.7	Comparison of Eurostat and IEA Formats for Natural Gas Balance	36
Figure 1.8	Comparison of Eurostat and IEA Formats for Gas/Diesel Oil Balance	37
Figure 2.1	Simplified Flow Chart for Electricity	43
Figure 2.2	Simplified Flow Chart for Heat	43
Figure 2.3	Table Relations within the Electricity and Heat Questionnaire	45
Figure 2.4	Simple Diagram Representing the Relationship between the Fuel Input and the Electricity and Heat Produced in a CHP Unit	48
Figure 3.1	Simplified Flow Chart for Natural Gas	58
Figure 3.2	Table Relations within the Natural Gas Questionnaire	59
Figure 3.3	Simplified Flow Chart for Natural Gas Production	61
Figure 4.1	Simplified Flow Chart for Oil	73
Figure 4.2	Table Relations within the Oil Questionnaire	74
Figure 4.3	Supply of Crude Oil, NGL, Refinery Feedstocks, Additives and Other Hydrocarbons	76
Figure 4.4	Simplified Flow Chart for Indigenous Production	77
Figure 4.5	Supply of Finished Products	79
Figure 4.6	Deliveries to the Petrochemical Sector	81
Figure 4.7	Oil Consumption by Sector	85
Figure 5.1	Simplified Flow Chart for Coal	98
Figure 5.2	Table Relations within the Coal Questionnaire	99
Figure 5.3	Coal Transformation Schematics	105
Figure 5.4	Calorific Values	109
Figure 6.1	Renewables and Waste Classification into Three Groups	116
Figure 6.2	Simplified Flow Chart for Renewables and Waste	120
Figure 6.3	Table Relations within the Renewables and Waste Questionnaire	121
Figure 6.4	Simplified Flow Chart for Group I Renewables and Waste	123
Figure 6.5	Simplified Flow Chart for Group II Renewables and Waste	123
Figure 6.6	Simplified Flow Chart for Group III Renewables and Waste	123
Figure 6.7	Renewables and Waste Consumption by Sector	127

Figure 7.1	Energy Balance Construction	136
Figure A1.1	Backpressure Power Plants	148
Figure A1.2	Steam Turbine with Extraction and Condensation	149
Figure A1.3	Gas Turbine with Heat Recovery	151
Figure A1.4	Reciprocating Internal Combustion Engines	152
Figure A1.5	Combined Gas/Steam Cycle in Co-generation	153
Figure A1.6	Operation of a Typical Refinery	155
Figure A1.7	Typical Mass Yields from Coke Ovens	157
Figure A1.8	Key Features of a Blast Furnace	160
Figure A2.1	Calorific Values of Fuelwood	174

List of Tables

Table 3.1	How to Calculate the Average Calorific Value of Imports	57
Table 4.1	Primary versus Secondary Oil	70
Table 4.2	Conversion from Volume to Mass – An example	73
Table 5.1	Primary and Derived Coal Products	94
Table 5.2	Difference between Gross and Net Calorific Values	96
Table 7.1	Eurostat Energy Balance Table for Spain, 1999	142
Table 7.2	IEA Energy Balance Table for Spain, 1999	144
Table A2.1	A Schematic Composition of Coal	167
Table A2.2	Solid Primary and Derived Coal Products	169
Table A2.3	Primary and Secondary Oil Products	171
Table A3.1	Most Common Multiple and Sub-multiple Prefixes	177
Table A3.2	Conversion Equivalents between Units of Volume	178
Table A3.3	Conversion Equivalents between Units of Mass	179
Table A3.4	Conversion Equivalents between Units of Energy	179
Table A3.5	Range of Calorific Values by Hard Coal Type	180
Table A3.6	Calorific Values by Coke Type	180
Table A3.7	Typical Calorific Values for Coal-derived Gases	181
Table A3.8	Typical Calorific Values for Selected Petroleum Products	181
Table A3.9	Conversion Factors from Mass or Volume to Heat (Gross Calorific Value)	182
Table A3.10	Conversion Equivalents between Standard Cubic Metres (Scm) and Normal Cubic Metres (Ncm)	182
Table A3.11	Conversion Equivalents between LNG and Natural Gas Units	183
Table A3.12	Gross versus Net Calorific Value of Natural Gas	183

1 Background

Energy has always played an important role in human and economic development and in society's well-being. For example, fuelwood has been used from time immemorial to make fire, and the first civilisations were already making use of wind in sailing overseas.

Wood was then abundant and free. People lived in small tribes and it was only when villages and small cities emerged that fuelwood became a traded commodity. As the size of cities increased, there was a greater need for energy, and forests started to be overexploited to the extent that in some areas a shortage of wood became apparent. It thus became necessary to monitor the supply and demand of wood.

The situation is different for wind; sailing boats still use wind freely. Millers continue to use wind freely to grind the grain in windmills. It is the appearance of the first wind turbines which prompted companies to measure the output of the wind force, i.e. the electricity generated, rather than the wind itself.

Without the heat and electricity from fuel combustion, economic activity would be limited and restrained. Modern society uses more and more energy for industry, services, homes and transport. This is particularly true for oil, which has become the most traded commodity, and part of economic growth is linked to its price.

However, neither oil nor any of the other fossil fuels, such as coal and natural gas, are unlimited resources. The combined effect of growing demand and depleting resources calls for a close monitoring of the energy situation. Other reasons for needing a profound knowledge of energy supply and demand include energy dependency, security and efficiency, as well as environmental concerns.

Strange as it may appear, it is precisely at a time when more and more energy is produced, traded, transformed and consumed, when energy dependency is increasing, and when greenhouse gas emissions are high on the international agenda, that it becomes more and more difficult to provide a timely and reliable picture of the energy situation in many countries.

Having a clear view of the situation implies detailed and reliable data on the different parts of the production and consumption chain. This involves proper reporting mechanisms, sound check procedures and adequate resources, in other words, mature and sustained energy statistics. However, liberalisation of the energy market, additional data requested from statisticians, budget cuts and the shortage of experienced staff have jeopardised the sustainability of some statistics systems, therefore the reliability of statistics.

This trend needs to be reversed urgently. Policy makers have to be aware of the seriousness of the situation and of the impact on the decision-making process. Data users need to be aware of some of the quality issues when using data. Statisticians need to make every effort to sustain and strengthen the statistics systems and to adapt them to the rapidly changing energy environment.

So there is a vast programme of actions ahead of us. One of the priorities should be to raise the level of expertise in basic energy statistics so that definitions and methodology can be applied. This is the reason why the *International Energy Agency* and the *Statistical Office of the European Communities* (Eurostat) have taken the initiative to prepare this *Energy Statistics Manual*.

The *Manual's* objective is not to provide an answer to all the questions linked to energy statistics. Its purpose is to provide the basics to the layman in energy statistics.

2 Overall Concept of the Manual

In line with the search for simplicity, the *Manual* was written in a question-and-answer format. The points developed are introduced with a basic question, such as: What do people mean by “fuels” and “energy”? What units are used to express oil? How are energy data presented?

Answers are given in simple terms and illustrated by graphs, charts and tables. More technical explanations are found in the annexes.

The *Manual* contains seven chapters: The first one presents the fundamentals of energy statistics, five chapters deal with the five different fuels (electricity and heat; natural gas; oil; solid fuels and manufactured gases; renewables and waste) and the last chapter explains the energy balance. Three technical annexes and a glossary are also included.

For the five chapters dedicated to the fuels, there are three levels of reading: the first one contains general information on the subject, the second one reviews issues which are specific to the joint IEA/OECD-Eurostat-UNECE questionnaires and the third one focuses on the essential elements of the subject.

3 The Use of the Manual in Conjunction with the Joint IEA/OECD-Eurostat-UNECE Questionnaires

Each year, the IEA, Eurostat and the United Nations Economic Commission for Europe collect annual statistics using a set of five joint questionnaires (oil, coal, gas, electricity and renewables) based on harmonised definitions, units and methodology.

Member countries receive a set of the questionnaires every year containing definitions, explanations and the tables. However, the text is limited in order not to overburden the statisticians responsible for completing the questionnaires.

The *Manual* should, therefore, be seen as a useful complement to the questionnaires, as it provides background information and a deeper knowledge of some of the difficult issues.

4

A More General Use of the Manual

Although there are references to the joint IEA/OECD-Eurostat-UNECE questionnaires in several places, the *Manual* can be used by statisticians and energy analysts from all countries.

Most of the text is relevant to general energy statistics concepts, regardless of the format and contents of any particular questionnaire. At the end of the day, electricity is the same all over the world. The same applies to flows such as “power plants” or “transmission losses”, as well as to units such as megawatts and gigawatt hours.

It is the hope of the International Energy Agency and of Eurostat that the *Manual* will facilitate the understanding of the fundamentals of energy statistics. We also hope that through this *Manual* a better understanding of statistics will raise expertise and lead to better energy statistics.

We are aware that the *Manual* will not provide answers to all questions. This is why your comments are welcome, so that we can, in a future edition, further improve the content and complement it by addressing the most frequent questions. Comments can be sent to the International Energy Agency at the following e-mail address: **stats@iea.org**.

Fundamentals



1 Introduction

As a first step, the energy statistician must be able to move comfortably between the units of measurement for fuels and energy and have a working knowledge of the main fuel conversion processes. Equally, the statistician will need to know the conventions and definitions used for the collection and presentation of energy statistics. This knowledge is loosely referred to as the methodology.

The paragraphs below and the annexes to the *Manual* will assist the statistician who is entering the field of energy statistics for the first time to acquire both the technical background of fuels and energy and to understand the statistical methodology.

There are a few basic concepts and defined terms which are essential to know since they are widely used in the discussion of fuels and energy. This chapter will introduce these notions as often as possible in a question-and-answer mode. The questions include: What do people mean by “fuels” and by “energy”? What are primary and secondary energy commodities? What is a commodity flow? How are energy data presented?

The answers are deliberately kept simple to give a sound basis to the statistician. They can then be completed by additional information given in other chapters of the *Manual*.

2 What do People Mean by “Fuels” and “Energy”?

An English dictionary defines a **fuel** as any substance burned as a source of heat or power. The heat is derived from the combustion process in which carbon and hydrogen in the fuel substance combine with oxygen and release heat. The provision of energy as heat or power in either mechanical or electrical form is the major reason for burning fuels. The term **energy**, when used accurately in energy statistics, refers only to heat and power but it is loosely used by many persons to include the fuels.

In this *Manual* as well as in the joint IEA/OECD-Eurostat-UNECE questionnaires, the term **energy commodity** will be used when a statement covers both fuels and heat and power. However, other energy statisticians may use synonyms like energy carrier, energy vector or energyware.

3 What are Primary and Secondary Energy Commodities?

Energy commodities are either extracted or captured directly from natural resources (and are termed **primary**) such as crude oil, hard coal, natural gas, or are produced from primary commodities. All energy commodities which are not primary but produced from primary commodities are termed **secondary** commodities. Secondary energy comes from the transformation of primary or secondary energy.

The generation of electricity by burning fuel oil is an example. Other examples include petroleum products (secondary) from crude oil (primary), coke-oven coke (secondary) from coking coal (primary), charcoal (secondary) from fuelwood (primary), etc.

Both electricity and heat may be produced in a primary or secondary form. Primary electricity is discussed later in the chapter on electricity. Primary heat is the capture of heat from natural sources (solar panels, geothermal reservoirs) and represents the arrival of "new" energy into the national supplies of energy commodities. Secondary heat is derived from the use of energy commodities already captured or produced and recorded as part of the national supplies (heat from a combined heat and power plant, for instance).

4 What are Fossil Fuels and Renewable Energy Forms?

Figure 1.1 • Terminology for Energy Commodities

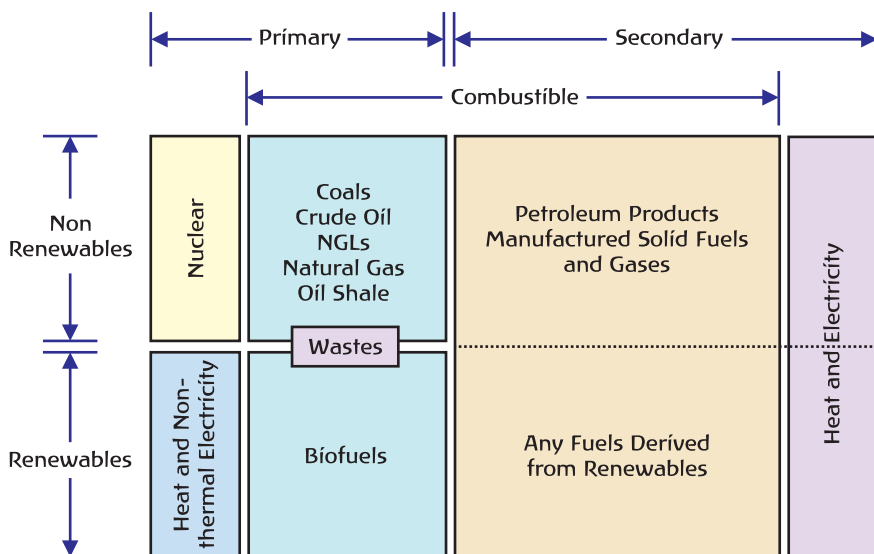

Primary energy commodities may also be divided into fuels of fossil origin and renewable energy commodities. **Fossil fuels** are taken from natural resources which were formed from biomass in the geological past. By extension, the term fossil is also applied to any secondary fuel manufactured from a fossil fuel. **Renewable energy** commodities, apart from geothermal energy, are drawn directly or indirectly from current or recent flows of the constantly available solar and gravitational energy. For example, the energy value of biomass is derived from the sunlight used by plants during their growth. Figure 1.1 gives a schematic illustration of renewable versus non-renewable energy, and primary versus secondary energy.

5 How to Measure Quantities and Heating Values?

Fuels are measured for trading purposes and to monitor processes which produce or use them. The units of measurement employed at the point of measurement of the fuel flow are those which are the best suited to its physical state (solid, liquid or gas) and require the simplest measuring instruments. These units are termed the **natural units** for the fuel (the term physical unit is also used). Typical examples are **mass units** for solid fuels (kilograms or tonnes) and **volume units** for liquids and gases (litres or cubic metres). There are some exceptions, of course; fuelwood, for instance, is often measured in cubic metres or in a volume unit employed locally.

Electrical energy is measured in an **energy unit**, kilowatt-hour (kWh). Quantities of heat in steam flows are calculated from measurements of the pressure and temperature of the steam and may be expressed in calories or joules. Apart from the measurements to derive the heat content of steam, heat flows are rarely measured but inferred from the fuel used to produce them.

It is also common to convert liquids measured in litres or gallons to tonnes. This enables the total quantity of different liquid products to be calculated. Conversion from volume to mass requires the densities of the liquids. Densities of common liquid fuels are given in *Annex 2*.

Once it is expressed in its natural unit, a fuel quantity may be converted into another unit. There are several reasons for doing so: comparing fuel quantities, estimating efficiency, etc. The most usual unit is an energy unit because the heat-raising potential of the fuel is often the reason for its purchase or use. Use of energy units also permits the summing of the energy content of different fuels in different physical states.

The conversion of a fuel quantity from natural units or some intermediate unit (such as mass) into energy units requires a conversion factor which expresses the heat obtained from one unit of the fuel. This conversion factor is termed the **calorific value** or heating value of the fuel. Typical expression of the values would be 26 gigajoule/tonne (GJ/t) for a coal or 35.6 megajoule/cubic metre (MJ/m³) for a gas. In this *Manual* the term "calorific value" will be used although "heating value" is also in widespread use.

The calorific value of a fuel is obtained by measurement in a laboratory specialising in fuel quality determination. Major fuel producers (mining companies, refineries, etc.)

will measure the calorific value and other qualities of the fuels they produce. The actual methods used to measure calorific value are not important for this *Manual* but the presence of water in fuel combustion will influence calorific value and this is discussed in the next section.

6 What is the Difference between Gross and Net Calorific Values?

Most fuels are mixtures of carbon and hydrogen and these are the main heating agents. There may be other elements which do not contribute, or contribute only slightly, to the calorific value of the fuel. Both the carbon and the hydrogen combine with oxygen during combustion and the reactions provide the heat. When the hydrogen combines with oxygen, it forms water in a gaseous or vapour state at the high temperature of the combustion. The water is therefore almost always carried away with the other products of combustion in the exhaust gases from the apparatus in which the combustion takes place (boiler, engine, furnace, etc.).

When the exhaust gases cool, the water will condense into a liquid state and release heat, known as latent heat, which is wasted in the atmosphere. The heating value of a fuel may, therefore, be expressed as a gross value or a net value. The **gross value** includes all of the heat released from the fuel, including any carried away in the water formed during combustion. The **net value** excludes the latent heat of the water formed during combustion. It is important when obtaining a calorific value to check whether it is net or gross. The differences between net and gross are typically about 5% to 6% of the gross value for solid and liquid fuels, and about 10% for natural gas.

There are a few fuels which contain no, or very little, hydrogen (for example blast-furnace gas, high-temperature cokes and some petroleum cokes). In these cases there will be negligible differences between net and gross calorific values.

The derivation of net calorific values for solid fuels is further complicated because they often contain water trapped within the fuel in addition to the water which will be formed from the hydrogen they contain. The reduction in net calorific value as a result of the additional water is uncertain because the dampness of the fuel may vary according to weather and storage conditions.

In summary, the net calorific value of a fuel is the total heat produced by burning it, minus the heat needed to evaporate the water present in the fuel or produced during its combustion. Major users of solid fuels, such as power stations, should be able to provide net calorific values based on the monitoring of the electricity generation.

7 What is a “Commodity Flow”?

Fossil fuels are extracted from natural reserves and biofuels are taken from the biosphere and either used directly or converted to another fuel product. A country may import a commodity it needs or export a commodity in excess of its requirements. Figure 1.2 illustrates the general pattern of the flow of a commodity from its first appearance to its final disappearance (final use) from the statistics.

Figure 1.2 • Main Commodity Flows

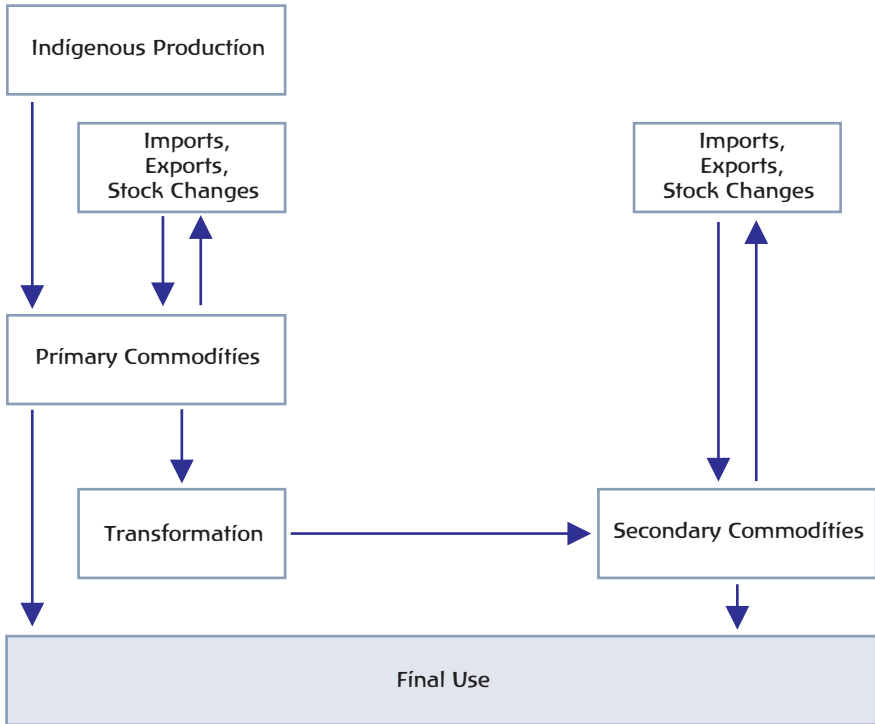

A **commodity flow** can be recorded at the main points between its arrival and disappearance, and the important criterion for a successful statistical account of the flow is that the commodity must not change its characteristics during its lifetime and that the quantities must be expressed in identical units for each source of supply and type of use. The characteristics which matter are those which affect its energy-producing capacity. For example, coal which is freshly mined will contain materials which are not coal and which are removed before sale. The coal “as mined” will not be the same as the coal consumed. Consequently, the production figure for coal used in energy statistics will be the amount of the coal when it has been washed and prepared for the market. Products which retain their key energy qualities at each point in the statistical account are considered homogeneous.

A similar flow diagram exists for heat and electrical or mechanical power. A discussion of these energy commodities needs to be conducted carefully as they are abstract in nature and their treatment in energy statistics is partly a matter of convention. The conventions affect both the assumed nature of the primary energy and the value given to its production.

Consider the energy obtained from any device driven mechanically by air or water (wind, hydro, wave, tidal power, etc.). In almost all cases the mechanical force present in the moving parts of the apparatus is used to generate electricity (there are of course a few exceptions such as pumping water from wind mills). As there is

no other outlet for the mechanical power before it is used for electricity generation, the energy form used to represent hydro, wind and tidal power is the electricity they generate. No attempt is made to adopt the mechanical energy as the primary energy form as it would have no utility in energy statistics. The primary electricity produced from these devices is sometimes referred to as non-thermal electricity as no heat is required for its production. Energy from photovoltaic (PV) cells which convert sunlight directly to electricity is considered as primary electricity and included with the sources of non-thermal electricity. In any case, the efficiency of a PV cell is relatively low.

Primary heat arises from geothermal reservoirs, nuclear reactors and solar panels converting incoming solar radiation to heat.

The form for nuclear energy is not the heating value of the nuclear fuel used as this is difficult to establish unambiguously. Instead, the heat content of the steam leaving the reactor for the turbine is used as the primary energy form.

8 What are the Main Flows Considered in Energy Statistics?

Production.....

Fuels

Fuels can be produced in a large diversity of ways: deep mine for **coal**, offshore platform for **oil**, forest for **fuelwood**, etc.

The production of primary **fossil fuels** is usually measured close to the point of extraction from the reserves. The quantities produced should be those measured when the fuels are in a marketable state. Any quantities which are not saved for use or sale should be excluded from the production figure. For example, some of the gases extracted from a gas or oil field may be returned to the field to maintain pressure (reinjecting gas), flared or released into the atmosphere (vented gas). The remaining gases may then be processed to remove some of the heavier gases (natural gas liquids). The production of marketable **natural gas** should be measured or calculated only after the reinjected gas, waste gas and the natural gas liquids have been removed (see chapter on natural gas).

Primary electricity and heat

Setting a figure for the production of primary electricity and heat is closely related to the definition of these two forms of energy in the different conditions of their exploitation. In general, the statistical production point is chosen to be a suitable measurement point as far "downstream" as possible from the capture of the energy flow before the energy flow is used. For example, for hydroelectricity, this will be the electricity generated at the alternators driven by the water turbines. For nuclear reactors, it will be the heat content of the steam leaving the reactor; there are a few cases where some steam is taken from reactors and used for district heating purposes as well as electricity generation. Where this does not occur, the steam input to the turbine may be used.

Production of Biofuels

Attempts to measure the production of biofuels are complicated by the absence of clearly defined production points. The widespread and scattered nature of biofuel use means that combustion of the fuel is often close to where it is collected and often no commercial transaction is involved. Certain biofuels, notably fuelwood, are traded in some countries but, from a global perspective, traded biofuels are only a small part of the total use.

Setting the figure for production of fuelwood and a few other biofuels is also complicated because they are only part of a much larger production for non-fuel uses. The major part of commercial wood production is for construction purposes and furniture, and only relatively small amounts are taken for fuel use, together with wastes during the manufacture of wood products. Similarly ethanol, which may be used as a blending component in motor gasoline, is produced from fermentation of biomass mainly for the food and drink industry and only a little is used for fuel blending.

In these cases, production is an imputed figure back-calculated to equal the total of the uses of the biofuel. It is the use which defines the commodity as a fuel. No attempt is made to assess the production directly or to include the production for non-fuel uses. Exceptions to the back-calculation procedure may become necessary in the future if the encouragement of biofuel use leads to established markets in specially manufactured biofuels (for example biodiesel). In this event, the commodity flow from production to final use should become clear through the usual commercial trading activities and the criterion for the definition of production used for fossil fuels will apply.

There are some countries where biofuels form part of the imports and exports. If a commercial market in the biofuel exists, then independent measurement of production may be a possibility. If not, the calculated production figure will need to be adjusted to take account of the import or export flow.

Often the heat content of the steam entering a turbine will not be known and must be estimated. This imputation is done by back-calculating from the gross electricity production, using the thermal efficiency of the plant. An identical approach may be used to estimate the geothermal heat input to turbines when direct measurement of the heat in the geothermal steam flow cannot be made. However, in this case a fixed thermal efficiency is used.

External trade

The trading of fuels between buyers and sellers in different countries raises a number of issues for reporting statistics of **imports** and **exports**. The most fundamental issue is to ensure that the definition of national territory (see box) is clear and applied in an identical manner to all energy commodities. If the country has "free trade zones", then there should be an established policy on their inclusion or exclusion from reporting and on the effects of the decision on the internal consistency of the commodity accounts, in particular on the national stocks and consumption figures.

What is the National Scope of Energy Statistics?

The territorial scope of the data collection which supports the energy statistics is clearly important for its use and its consistency with other economic statistics. The energy statistician should ensure that this statistical boundary is known and stated in the bulletins or statistical digests. The definition of the boundary should make clear which distant territories are under national jurisdiction and whether they are included in the energy data. In particular, are distant islands considered part of the national territory? Is fuel consumption in the islands and for air flights from the mainland to the islands included in the national energy statistics as domestic fuel use? Equally, are fuel consumption and fuel supplies entering and leaving any free trade zones in the country included in the national data?

The coverage of national consumption data is also influenced by the manner in which the data are collected. Consumption data are generally collected by a mixture of two types of surveys:

- Direct surveys of consumers, or
- Surveys of fuel suppliers in which the supplier classifies deliveries according to the economic activity or the type of customer.

It is usual for major combustion plants such as power stations to provide details on their consumption directly to the statistical office. Consumption data in manufacturing industries may be collected by either method, whereas consumption by the tertiary sector and households is estimated through surveys of deliveries from suppliers.

The difference between the estimate of consumption from deliveries to a consumer and the actual consumption will be the changes in the consumer's stocks. Consequently, when direct surveys of consumption take place, it is important that the consumers' stock levels be reported as their changes in level must be included in the national stock level changes.

Imports and exports of commodities are the quantities entering and leaving a given country as a result of purchases and sales made by persons living in that country. The import or export is considered to take place when the commodity crosses the national boundary, whether or not clearance by the customs authority has taken place. In order to keep the external trade figures for fuels and energy consistent with major economic indicators, the purchases should be, at least partly, for domestic use. This requires that quantities passing through a country "in transit" should not be included in import or export figures. Equally, the correct identification of trade origins and destinations not only serves to isolate transit trade but provides essential information on the country's dependence on foreign supplies.

Trade origins and destinations are usually available for the fuels shipped as cargoes (fuels which can be easily stocked) but similar information for network energy commodities is more difficult to obtain. Gas or electricity meters will give accurate figures for physical quantities crossing national borders but no information on origins and final destinations. Also, in newer electricity markets, the country of

origin of the electricity may differ from the country in which the seller's company is registered. For example, a Spanish electricity company may sell electricity to a Belgian consumer and arrange for the supply to be made from France. With network energies traded in open markets, clear differences can emerge between the commercial trade flow and the physical flow.

For national and international statistical purposes, therefore, it is not practicable to insist on a precise identification of origins and destinations for electricity. Instead, reporting should be based on the physical flows and the countries of origin and destination will be neighbouring countries. It follows that, for electricity, transit quantities will be included.

The reporting of external trade in natural gas should, however, identify the true origins and destinations for the gas. Over the past two decades the international gas market has developed considerably through the introduction of new pipelines and the use of liquefied natural gas (LNG) transport where pipelines are not practicable. Unlike the production of electricity, the production of natural gas is dependent on the existence of natural reserves and this introduces the issues of gas supply dependence of a country or region on another. In order to provide the true information on origins and destinations, national statisticians will need to collaborate closely with the importing and exporting gas companies.

International marine bunkers

Deliveries of oils to ships for consumption during international voyages (bunker oils) represent a special case of flows of oil from the country. The oils are used as fuel by the ship and are not part of the cargo. All ships, irrespective of the country of registration, should be included but the ships must be undertaking international voyages. International marine bunkers statistics should include fuel delivered to naval vessels undertaking international voyages. Care should be taken to ensure that data representing oil delivered for international marine bunkers meet the definition given here and, in particular, exclude bunker oil used by fishing vessels.

The engines in large ships sometimes use fuels which differ in quality from similarly named fuels used ashore. If this occurs, the nature of the differences (in particular the calorific value) should be sought and noted as energy balance calculations, and emission inventories may require the differences to be taken into account.

One of the reasons why it is essential to have a special oil flow for international marine bunkers is related to the way emissions from international marine bunkers and international civil aviation are reported in national inventories to the United Nations Framework Convention on Climate Change (UNFCCC). These emissions are in fact excluded from national inventories.

Stocks

Stocks of fuels serve to maintain operations when supplies or demand vary in a manner which causes demand to differ from supply. Stocks are held by fuel suppliers to cover fluctuations in fuel production and/or imports, and orders for fuels. Stocks are held by consumers to cover fluctuations in fuel deliveries and consumption. Stocks held by suppliers and power generators should always be

included in the national fuel statistics. Stocks held by other consumers are included only if figures for consumption by the consumers are based on surveys of consumption at consumers' premises.

Unlike the other "flow" elements of the statistical account (consumption, imports, production, etc.) which relate to the complete reporting period, stocks have values (levels) which may be measured at specific instants of time. The stock levels at the beginning and end of the reporting period are known as the **opening stock** and **closing stock** respectively. A flow of fuel arises from a change in stock level and it is the **stock change** which enters the statistical account. The stock changes resulting from an increase in stocks (closing stock > opening stock) and a decrease (opening stock > closing stock) are known respectively as a **stock build** and a **stock draw**.

Not all stocks on national territory should be included in national stock levels. The criterion for deciding which stocks may be included is their availability to meet any excess of demand for the fuel over supply or vice versa.

There is a large variety of types of stocks, especially for petroleum products, and great care should be taken when allocating the quantities to the relevant stock category. The types of stocks for crude oil and petroleum products include, for instance, those held by governments, by major consumers, by stockholding organisations, stocks held on board incoming ocean vessels, stocks held in bonded areas, etc. The breakdown of the types should be tailor-made to the need and use of the data (energy security, emergency, etc.).

Fuel transformation.....

Fuel transformation or **fuel conversion** changes a primary fuel, by physical and/or chemical means, into a secondary energy commodity which is better suited than the primary to the uses for which the secondary commodity is intended. The various processes of fuel conversion and energy production are described in detail in *Annex 7*. Examples are the manufacture of coke from coal in coke ovens or the generation of electricity from steam produced by burning fuels.

Although both examples are considered by energy statisticians as transformation processes, it is important to note that they are fundamentally different. The manufacture of coke is an example of a true conversion process which is essentially a separation process. In this case, most carbon from the coal is left within the coke, and the hydrogen in the coal with some carbon goes into coke-oven gas and some oil products. All may be regarded as fuels and, ideally, no combustion takes place within the process. In contrast, the generation of electricity from burning fuels requires the combustion of the fuels and some of the energy in the heat (steam) produced is converted into electricity. The carbon and hydrogen present in the original fuels are lost and emitted into the atmosphere as carbon dioxide (CO₂) and water.

The production of heat in heat plants is also the direct result of combustion and is identical in nature to heat-raising by final consumers. However, the production of heat (steam) for sale is considered a transformation activity because, by including it in the transformation sector, the heat sold will appear within the total heat supply and its consumption by final users recorded. The fuel used to produce the heat sold

must also be included in the transformation sector. If this practice were not adopted, then heat produced and sold by manufacturing enterprises would not appear in the balance with the consequence that the fuel consumption by enterprises would be overstated and the heat used by final consumers understated.

Fínal consumption.....

The final consumption of fuels covers their use for heat-raising and for non-energy purposes. Fuels used for the production of electricity and heat for sale, as well as the quantities of the energy produced, are excluded from final consumption and accounted for under transformation.

Fínal energy consumption

Final energy consumption covers deliveries of commodities to consumers for activities that are not fuel conversion or transformation activities as defined elsewhere in the balance structure. The energy commodities are considered consumed and not transformed into others. In short, they disappear from the account.

Quantities shown are intended to represent the energy needs of the economic activity under which they are classified. Within the industry sector, for example, consumption of energy commodities will be for final use without transformation into other commodities.

The statistics contained within this part of the commodity balances are mainly taken from reports of deliveries made by energy industries to enterprises classified by principal economic activity or by direct survey of consumers. Classification of companies is undertaken locally, either by the energy company or by the national administration, using the national classification system for economic activities. Within the European Union, this system will be directly comparable with the *Nomenclature Générale des Activités Economiques dans les Communautés Européennes* (NACE rev. 1) and, elsewhere, countries have adopted or are adopting national classifications based on the *International Standard Industrial Classification* (ISIC rev. 3). The two international systems are identical down to the three-digit level. The widespread adoption of common classification schemes is essential for true comparability between the energy statistics of different countries. Despite the good comparability which currently exists, users should always be aware that any time series of data may span periods when the national classifications used differed from the international norms then in place.

Industry

Industrial enterprises use energy commodities for heat-raising for own use, for non-energy purposes, transport, electricity generation, and production of heat for sale. Fuels used for the last three categories are not part of final energy consumption and are usually reported elsewhere in a questionnaire. Fuel used for transport by enterprises should be reported under the transport sector of final consumption. Statistics of fuel use by enterprises may be obtained from direct enterprise surveys or be inferred from deliveries of fuels to them. In the latter case, it is often difficult to obtain sufficient information to separate use of the fuels for the different purposes listed above. Usually the particular fuel used will define the activity but sometimes

significant differences in taxation of similar oils for different uses may obscure identification of the correct category of use.

The industry sector is divided into twelve branches. The NACE codes defining them are given in the annual questionnaires. Only two branches need comment.

Quantities recorded as consumption by the **chemical industry** branch represent use of fuels for heat-raising and for feedstock use although quantities used for the latter are usually also shown elsewhere in the questionnaires. Feedstock use is discussed in the following section on *Non-energy uses of fuels*.

Similarly, figures for final energy consumption by **iron and steel manufacture** cover only the combustion requirements for heating coke ovens, blast furnaces and metal finishing. Quantities of coal and coke undergoing transformation are reported within the transformation sector.

Transport

Five main transport modes are identified within this sector. The figures given relate to use for the transport activity itself and not for consumption by the transport company for non-transport purposes. Usually the cost of transport fuels inhibits their use for non-transport purposes. Only four of the modes require comment:

- Road It is common for all road transport fuels to be shown as supporting the transport activity. Some will be used, however, off-road for digging, lifting and agricultural or forestry needs. Small but significant quantities will be used for pleasure craft and powered garden equipment. Consumption for these diverse uses can be obtained only by survey. None of these off-road quantities should be included as road transport.
- Air Where separate data are available for deliveries of fuel to aircraft undertaking international flights, the figures are shown in international civil aviation (see the discussion under *International marine bunkers* above). In the absence of separate data, all deliveries should be attributed to domestic air.
- Pipelines Fuel and electricity use at compressor and/or pumping stations, on pipelines carrying gas, oil or coal slurry is reported under this heading.
- Inland navigation All fuel consumption for transport of goods or persons on inland waterways and for national sea voyages should be included. A national sea voyage is one which starts and ends in the same country without any intermediate foreign port of call. Note that an extensive part of the voyage may take place in international waters, for example Le Havre to Marseilles. Fuel consumed by fishing vessels of all types (inland, coastal or deep-sea) should be included under consumption for agriculture.

Other sectors: residential, commerce, public services, etc.

- **Agriculture** Energy use for forestry and fishing, including deep-sea fishing, should be included here. However, fuels delivered for deep-sea fishing are sometimes omitted from this sector and included in international marine bunkers statistics when they should not. A small part of the deliveries of gas/diesel oil for road transport is consumed within this sector as “off-road” use of the fuel.
- **Residential** Statistics of energy consumption in households are collected in a variety of ways in different countries. Gas and electricity consumption data are usually derived from meter-readings made by the utility companies. Consumption of stockable fuels may be obtained by calculating the difference between all deliveries and those to economically active sectors to which deliveries are recorded. Some countries also conduct surveys of household energy consumption which serve to reveal any bias in delivery-based statistics.

Non-energy uses of fuels

A number of fuels may be used for non-energy purposes. These are:

- As raw materials for the manufacture of non-fuel products (feedstock use). The use of the hydrocarbon content of fuels as raw material is an activity which is almost entirely confined to the refining and petrochemical industries.
- For their physical properties. Lubricants and greases are used in engines for their “slippery” qualities, and bitumen on roofs and roads for its waterproofing and wear qualities.
- For their solvent properties. White spirit and other industrial spirits are used as diluents in paint manufacture and for industrial cleaning purposes.

The petrochemical industry represents, by far, the most important user of fuels for non-energy purposes. It converts fossil fuels (oil, natural gas and coke-oven by-products) and biomass carbon to synthetic organic products.

Steam cracking of either refinery oil products or natural gas liquids is the key petrochemical conversion process. The feedstock includes naphtha, gas oil, and liquefied petroleum gas (LPG). Ethane, propane and butane from natural gas processing may also be used if readily available.

Steam cracking results in a variety of intermediate chemicals (ethylene, propylene, butadiene, benzene, toluene and xylene) and by-products (hydrogen, methane and pyrolysis gasoline) used as fuels and/or returned to refineries. The quantities returned to refineries are referred to as **backflows**.

Solid carbon, usually in the form of coke, is used for several non-energy processes in the chemicals sector. These include the manufacture of soda ash, silicon carbide and carbon anodes. The latter are usually made from high-quality (calcined) petroleum coke while both coke-oven coke and “green” petroleum coke are used for the other processes.

Electricity Use

Almost all consumption of electricity is for power, heat and electronic use resulting in the disappearance of the electrical energy as heat. Electricity should therefore never be reported as non-energy use. Use of electricity for electrolysis occurs in some industries but statistics distinguishing this use from other uses in the enterprises are not usually available and as a consequence all consumption should be reported as energy use.

9 How are Energy Data Presented?

To collect reliable statistics is one thing. To disseminate this information in a clear and comprehensive manner is another thing.

Commodity balance format

The most commonly used format for the presentation of energy commodity data is the balance in which both the sources of supply for each commodity and its uses are shown in a single column. The balance format is conceptually identical to a simple cash account where the sources of income should, when summed, balance the total of expenditures after changes in cash deposits are taken into account.

Figure 1.3 • Commodity Balance Structure

Sources of supply (Fig. 1.4)
 + Transfers between commodities
 = **DOMESTIC SUPPLY**
statistical difference
TOTAL DEMAND =
 Transformation input
 + Energy sector own use
 + Distribution and other losses
 + **FINAL CONSUMPTION =**
 Non-energy use
 + Final energy consumption

The balance format is appropriate for energy commodities provided that they are homogeneous at each point in the balance. This requirement is explained in Section 7 on commodity flows. In addition, energy commodities should be expressed, as far as possible, in mass or energy units as volume units (cubic metres) are dependent on pressure or temperature.

The main framework of a commodity balance is shown in Figure 1.3. The actual commodity balance formats used by countries and international organisations differ from one another and from the simplified format in Figure 1.3. However, the model given here will illustrate the main points and the differences between organisations. The differences between the IEA and Eurostat balances will be discussed below.

The balance is calculated according to the arithmetic rules shown in Figure 1.3. The *sources of supply* are supplemented (or reduced) by any *transfers between commodities* and the total represents the *domestic supply* meeting the country's needs. The *total demand* is the sum of the uses for *transformation input*, use *within*

the energy sector for needs other than transformation, any losses between the points of production of the energy commodities and their final use, and the final consumption. The final consumption is the sum of the non-energy and energy uses.

The main headings in Figure 1.3 are further detailed below. **Sources of supply** are broken down into their main elements, as in Figure 1.4.

Figure 1.4 • Sources of Supply

Production
Other sources
Imports
Exports
International marine bunkers
Stock change

Production covers indigenous production and the manufacture of secondary fuel products. *Indigenous production* is the extraction of primary fuels from fossil reserves and biofuel sources as well as the capture of renewable energy from water, wind, sunlight, etc. Indigenous production is termed “primary production” by Eurostat.

Other sources of production are rare and the heading is present to cover

sources of fuels which are recovered from fuels already produced but not counted or saved. For example, waste coal may be later recovered for use.

Imports have already been discussed with *Exports* in the section *External trade*. It may seem strange to include exports as a source of supply and there are economic models of energy use which treat exports as a part of demand. However, the energy balance seeks to show the supply of fuels used within the country and so exports are subtracted to calculate the total domestic supply. The arithmetic sign convention for imports and exports depends on the formula used to construct the total supply figure. It is usual to give exports a negative sign as they are withdrawals from supply and the quantity is then simply summed with the other elements to produce the total.

International marine bunkers, see section above, are also included as a withdrawal from supply in this part of the balance.

Stock change is the difference between opening and closing stock levels. A stock draw is an addition to supply and so will be entered with a positive sign. The converse applies for a stock build. In both cases $\text{stock change} = \text{opening} - \text{closing}$ stock levels.

Transfers between commodities are not major flows and arise primarily from the reclassification of commodities. A product may cease to meet its specification and will be reclassified as another commodity of lower quality. The “transfers” row may also be used as a practical device to bring different commodities into another single commodity grouping. For example, in the Eurostat balances, separate balances for hydro and wind electricity show transfers of the production to the electricity balance where the disposal of all electricity is shown. Clearly, entries in the transfers row may have positive or negative signs depending on whether they are additions to or removals from supply of the commodity.

Domestic supply is the total of all sources of supply and the transfers between commodities.

The figures reported under **Transformation input** are the quantities of the fuels used for the manufacture of secondary fuel products and the fuels burned to generate electricity and heat for sale. The various headings in this part of the

balance are the different fuel and energy plants involved in secondary fuel and energy production. They may be grouped as follows to simplify the explanation of the activities they perform:

■ *Electricity and heat generation*

These are further divided into Electricity-only plants, Combined heat and power plants (CHP) and Heat-only plants. These types of plants may be operated by enterprises which are producing the electricity and/or heat for sale as their main business or by enterprises which are not producing the energy as their main business but primarily for their own consumption. The enterprises of the first group are called public or main power producers (MPPs) and those in the second group autogenerators or autoproducers.

■ *Solid fuel and gas manufacture*

Three main conversion plants are recognised in this group: the manufacture of coke from coal heated in coke ovens, the use of coke and other fuels in blast furnaces, and the manufacture of patent fuels from various coal types. Coke oven and blast furnace operations usually take place in the iron and steel industry. The two types of plants produce gases which are used on site and may be sold to users off site. A coke of lower quality than that used for blast furnaces is produced in a few countries during the manufacture of town gas in gas works. Coke manufacture also produces light oils and tars.

Blast furnaces are not designed to be fuel conversion plants but plants for the manufacture of iron, most of which is later converted to steel. However, for the purposes of energy statistics, they are considered to be part of the transformation sector. If they were not included in this manner, then it would be impossible to track the fuel required to produce the blast-furnace gases which are then used for energy purposes.

Patent fuel production is usually located close to sources of coals (hard coals, brown coals and lignite) as the process is essentially the aggregation of small and finely divided coals into useable briquettes. Some patent fuel production is based on the low-temperature carbonisation of coal and is similar to coke manufacture in gas works. The various processes are described in more detail in *Annex 1*.

■ *Petroleum refineries*

Petroleum product manufacture from the refining of crude oils and treatment of semi-finished products is mainly conducted within *petroleum refineries*. The quantities of oils reported as entering the refineries for the fuel conversion process will provide the materials for the products manufactured (including non-fuel products) and fuel use within the refinery.

■ *Other transformation*

This grouping covers less-used fuel conversion processes which are not identified separately.

Energy sector own use: This part of the balance shows the quantities of energy commodities consumed within the fuel and energy enterprises in the sense that they disappear from the account rather than appear as another energy commodity. The

commodities are used to support the various activities within the fuel extraction, conversion or energy production plant but they do not enter into the transformation process.

It is customary to distinguish final consumption within the energy sector from other parts of industrial activity although, by its nature, it is part of the final consumption of the industry sector. The energy consumed by the enterprise may be purchased directly for consumption or be taken from the energy commodities it extracts or produces.

The headings used for the activities in this part of the account include those used in the transformation industries together with the fuel extraction and preparation industries (coal mining, oil and gas extraction, gas liquefaction, nuclear fuel processing, etc.).

Distribution and other losses: Entries in this part of the balance are separate from the energy sector and represent the losses of energy commodities during their distribution to the points of use. The transmission and distribution losses associated with the electricity and gas networks provide simple examples but there are cases related to the distribution of blast-furnace and coke-oven gases and oil products by pipeline.

Non-energy use: The nature of non-energy use is described in Section 8 *Non-energy uses of fuels*. The presentation of the figures in the balance does not distinguish between the various economic sectors within which the use occurs, except in a very limited manner. Usually, the non-energy use by the petrochemical industry is identified. However, in the IEA balances, feedstock use in the petrochemical industry is included as a separate line in the final energy consumption.

Final energy consumption: It is divided between three major groups: *Industry*, *Transport* and *Other sectors*.

Figure 1.5 • Industry

Iron and steel
Chemicals and petrochemicals
Non-ferrous metals
Non-metallic minerals
Transport equipment
Machinery
Mining and quarrying
Food, beverages and tobacco
Pulp, paper and print
Wood and wood products
Textiles and leather
Construction
Not elsewhere specified

Industry: The branches of the industry sector for which data are required are shown in Figure 1.5. The definitions of these branches in terms of the economic activities they contain are given by reference to ISIC rev. 3 and NACE rev. 1, see section on *Final energy consumption* above. The industry sector includes the construction branch but not the energy industries.

The figures reported in the industry sector for the consumption of fuels by enterprises should exclude quantities used to generate electricity and that part of heat that is for sale. Where practicable, they should also exclude fuels used for transportation of goods on public roads. Consumption for road transport should be reported under Transport.

Transport: At least four transport modes are identified: *road, rail, air* and *national navigation*. The IEA, in addition, includes pipeline transport (transport of materials by pipeline); Eurostat treats this consumption as part of the energy sector own use. The amounts of fuels included under these headings cover the fuel use for propulsion only. Fuel used by transport enterprises for other purposes must not be included here but under “Commerce and public services” (see “Other sectors” below). Usually, the quantities for transport are easily identified because fuels for road engines and aircraft differ from heating fuels, but some confusion is possible where engines use gas/diesel oil and care may be required to separate the vehicle and enterprise use. Energy use for pipelines is usually electricity, or where gas is transported, some of the gas is used to drive the compressors. It is important that this gas use be correctly reported and not considered to be part of the distribution losses.

Figure 1.6 • Other Sectors

Agriculture
Commerce and public services
Residential
Other

Other sectors: There are differences between international organisations and countries in their choice of headings under “Other sectors” although all activities are included somewhere. The most common breakdown is shown in Figure 1.6.

The heading “Agriculture” covers agriculture, forestry and fishing. Oil consumption for fishing should include all fishing vessels, including those engaged in deep-sea fishing. It is therefore important to ensure that oils delivered to deep-sea fishing vessels are not included in the quantities reported as “International marine bunkers”.

National statisticians should pursue large **statistical differences** in order to establish which data are wrong or incomplete. Unfortunately, it will not be always possible to correct the data and, in this case, the statistical difference should not be changed but left to illustrate the size of the problem.

Deciding whether a statistical difference should be pursued with the reporting enterprise(s) is a matter of judgement. The percentage difference which one might consider acceptable will depend upon the magnitude of the supply of the commodity. For major supplies, like natural gas or electricity, efforts should be made to keep the statistical differences below one per cent. On the other hand, for a minor commodity like tars and oils from coke ovens, a 10% error can be tolerated.

When the commodity balances are constructed from the data reported to the statistician, it may also show a statistical difference which is zero (a “closed” balance). This apparently ideal position should be regarded with suspicion as, in almost all situations, it indicates that some other statistic in the balance has been estimated to balance the account. This usually occurs when the data come from a single reporter (for example a refinery or an iron and steel works) who has all the data making up the balance and is therefore able to adjust figures to close the balance. For information and an appreciation of the data problems encountered by the enterprise concerned, the statistician should discover what element(s) has (have) been estimated to balance the report.

Two examples of commodity balance: Eurostat and IEA

The above descriptions can now be illustrated by showing the commodity balance formats used by Eurostat and the IEA and comparing them. Figure 7 and Figure 8 give examples of the formats for Eurostat and the IEA for natural gas and gas/diesel oil supply and use in France for the year 1999 as an illustration of the manner in which each organisation presents a primary and secondary fuel.

The two commodity balances differ in structure in one important respect which influences the presentation of secondary energy commodities. In the Eurostat commodity balance, the transformation sector is divided into input and output, whereas the IEA has only an input part. The output (production) of secondary commodities is shown as "Production" in the IEA format and "Transformation output" by Eurostat. Eurostat reserves the production row for (indigenous) primary production only (see Figure 1.7). The IEA production row shows indigenous production or secondary production depending on the commodity.

The format difference has important consequences for some of the main aggregates in the commodity balances. Note, for example, that the figures in the gas/diesel oil balances for "Gross inland consumption" and "Domestic supply" do not correspond with each other (see Figure 1.8). Eurostat's "Gross inland consumption" is essentially the consumption of net externally provided supply. It could be a negative figure if exports were sufficiently large. To reproduce the IEA "Domestic supply" figure, it is necessary to add the refinery production of gas/diesel oil within the transformation output part of the balance.

The use of two separate rows for output enables Eurostat to distinguish between indigenous and secondary production and, consequently, to adopt an identical format for both the commodity and energy balance. This point will become clear when energy balances are discussed in Chapter 7.

There are many other small differences between the two formats but they are largely matters of choice of names and order of presentation rather than substantive differences in approach.

Figure 1.7 • Comparison of Eurostat and IEA Formats for Natural Gas Balance

FRANCE 1999		NATURAL GAS		Terajoules (GCV)	
EUROSTAT format		IEA format			
Primary production	77 670	Production	77 670		
Recovered products	-	From other sources	-		
Imports	1 649 710	Imports	1 649 710		
Stock change	-92 853	Exports	-30 456		
Exports	-30 456	Intl marine bunkers	-		
Bunkers	-	Stock change	-92 853		
Gross inland consumption	1 604 071	DOMESTIC SUPPLY	1 604 071		
Transformation input	49 791	Transfers	-		
Public thermal power stations	1 805	Statistical difference	-20 440		
Autoprod. thermal power stations	47 986	TRANSFORMATION	49 791		
Nuclear power stations	-	Electricity plants	49 791		
Patent fuel and briquetting plants	-	CHP plants	-		
Coke-oven plants	-	Heat plants	-		
Blast-furnace plants	-	Blast furnaces/gas works	-		
Gas works	-	Coke/pat. fuel/BKB plants	-		
Refineries	-	Petroleum refineries	-		
District heating plants	-	Petrochemical industry	-		
Transformation output	-	Liquefaction plants	-		
Public thermal power stations	-	Other transformation sector	-		
Autoprod. thermal power stations	-	ENERGY SECTOR	17 320		
Nuclear power stations	-	Coal mines	-		
Patent fuel and briquetting plants	-	Oil and gas extraction	9 715		
Coke-oven plants	-	Petroleum refineries	-		
Blast-furnace plants	-	Electricity and heat plants	-		
Gas works	-	Pumped storage	-		
Refineries	-	Other energy sector	7 605		
District heating plants	-	Distribution losses	2 619		
Exchanges and transfers, returns	-	FINAL CONSUMPTION	1 513 901		
Interproduct transfers	-	INDUSTRY SECTOR	661 262		
Products transferred	-	Iron and steel	39 614		
Returns from petrochem. industry	-	Chemical and petrochemical	199 241		
Consumption of the energy branch	17 320	of which: Feedstock	103 146		
Distribution losses	2 619	Non-ferrous metals	17 180		
Available for final consumption	1 534 341	Non-metallic minerals	78 163		
Final non-energy consumption	103 146	Transport equipment	-		
Chemical industry	103 146	Machinery	74 125		
Other sectors	-	Mining and quarrying	6 449		
Final energy consumption	1 410 755	Food and tobacco	106 468		
Industry	558 116	Paper, pulp and print	66 401		
Iron & steel industry	39 614	Wood and wood products	-		
Non-ferrous metal industry	17 180	Construction	2 371		
Chemical industry	96 095	Textile and leather	19 183		
Glass, pottery & building mat. industry	78 163	Non-specified	52 067		
Ore-extraction industry	6 449	TRANSPORT	28		
Food, drink & tobacco industry	106 468	International civil aviation	-		
Textile, leather & clothing industry	19 183	Domestic air	-		
Paper and printing	66 401	Road	14		
Engineering & other metal industry	74 125	Rail	-		
Other industries	54 438	Pipeline transport	-		
Transport	28	Internal navigation	-		
Railways	-	Non-specified	14		
Road transport	14	OTHER SECTORS	852 611		
Air transport	-	Agriculture	11 729		
Inland navigation	-	Commerce and pub. services	399 324		
Households, commerce, pub. auth, etc.	852 611	Residential	441 558		
Households	441 558	Non-specified	-		
Agriculture	11 729	NON-ENERGY USE	-		
Statistical difference	20 440	Industry/transformation/energy	-		
		Transport	-		
		Other sectors	-		

Figure 1.8 • Comparison of Eurostat and IEA Formats for Gas/Diesel Oil Balance

FRANCE 1999		GAS/DIESEL OIL		kilotonnes	
EUROSTAT format		IEA format			
Primary production	-	Production		32 621	
Recovered products	-	From other sources		-	
Imports	11 668	Imports		11 668	
Stock change	1 213	Exports		-2 230	
Exports	-2 230	Intl marine bunkers		-419	
Bunkers	-419	Stock change		1 213	
Gross inland consumption	10 232	DOMESTIC SUPPLY		42 853	
Transformation input	48	Transfers		-529	
Public thermal power stations	18	Statistical difference		2 265	
Autoprod. thermal power stations	23	TRANSFORMATION		384	
Nuclear power stations	-	Electricity plants		41	
Patent fuel and briquetting plants	-	CHP plants		-	
Coke-oven plants	-	Heat plants		-	
Blast-furnace plants	-	Blast furnaces/gas works		-	
Gas works	-	Coke/pat. fuel/BKB plants		-	
Refineries	-	Petroleum refineries		-	
District heating plants	-	Petrochemical industry		336	
Transformation output	32 621	Liquefaction plants		-	
Public thermal power stations	-	Other transformation sector		7	
Autoprod. thermal power stations	-	ENERGY SECTOR		4	
Nuclear power stations	-	Coal mines		-	
Patent fuel and briquetting plants	-	Oil and gas extraction		-	
Coke-oven plants	-	Petroleum refineries		4	
Blast-furnace plants	-	Electricity and heat plants		-	
Gas works	-	Pumped storage		-	
Refineries	32 621	Other energy sector		-	
District heating plants	-	Distribution losses		-	
Exchanges and transfers, returns	-865	FINAL CONSUMPTION		44 201	
Interproduct transfers	0	INDUSTRY SECTOR		2 475	
Products transferred	-529	Iron and steel		35	
Returns from petrochem. industry	-336	Chemical and petrochemical		1 383	
Consumption of the energy branch	4	of which: Feedstock		1 383	
Distribution losses	-	Non-ferrous metals		15	
Available for final consumption	41 936	Non-metallic minerals		122	
Final non-energy consumption	1 383	Transport equipment		48	
Chemical industry	1 383	Machinery		152	
Other sectors	-	Mining and quarrying		1	
Final energy consumption	42 818	Food and tobacco		110	
Industry	1 092	Paper, pulp and print		14	
Iron & steel industry	35	Wood and wood products		-	
Non-ferrous metal industry	15	Construction		409	
Chemical industry	0	Textile and leather		38	
Glass, pottery & building mat. industry	122	Non-specified		148	
Ore-extraction industry	1	TRANSPORT		26 801	
Food, drink & tobacco industry	110	International civil aviation		-	
Textile, leather & clothing industry	38	Domestic air		-	
Paper and printing	14	Road		25 948	
Engineering & other metal industry	200	Rail		368	
Other industries	557	Pipeline transport		-	
Transport	26 801	Internal navigation		485	
Railways	368	Non-specified		-	
Road transport	25 948	OTHER SECTORS		14 925	
Air transport	-	Agriculture		2 026	
Inland navigation	485	Commerce and pub. services		4 450	
Households, commerce, pub. auth, etc.	14 925	Residential		8 442	
Households	8 442	Non-specified		7	
Agriculture	2 026	NON-ENERGY USE		-	
Statistical difference	-2 265	Industry/transformation/energy		-	
		Transport		-	
		Other sectors		-	

Electricity & Heat



1 What are Electricity and Heat?

General information

Electricity is an energy carrier with a very wide range of applications. It is used in almost all kinds of human activity ranging from industrial production, household use, agriculture, commerce for running machines, lighting and heating.

The first studies of electrical phenomena were conducted in the beginning of the 17th century and continue today. The start of industrial use of electricity can be set in the year 1879 when Thomas Alva Edison invented and publicly presented the light bulb. Since then, the use of electricity has been growing and gaining importance in everyday life.

Electricity is produced as primary as well as secondary energy. **Primary electricity** is obtained from natural sources such as hydro, wind, solar, tide and wave power. **Secondary electricity** is produced from the heat of nuclear fission of nuclear fuels, from the geothermal heat and solar thermal heat, and by burning primary combustible fuels such as coal, natural gas, oil and renewables and wastes. After electricity is produced, it is distributed to final consumers through national or international transmission and distribution grids.

Heat, as electricity, is an energy carrier primarily used for warming spaces and industrial processes. The history of heat is almost as long as the history of humankind and started with the discovery of fire.

Heat is also produced as primary as well as secondary energy. **Primary heat** is obtained from natural sources such as geothermal and solar thermal power. Secondary heat is obtained from the nuclear fission of nuclear fuels, and by burning primary combustible fuels such as coal, natural gas, oil and renewables and wastes. Heat is also produced by transforming electricity to heat in electric boilers or heat pumps. Heat can be produced and used on site, or distributed through a system of pipes to structures remote from the point of production.

As noted above, electricity is used in almost every human activity. It is used in homes, for heating, lighting and operating home appliances. It is used in the workplace, powering machines in factories, computers in offices, equipment in hospitals. It is used in transportation, agriculture and other sectors of the economy.

This wide use of electricity is of course reflected by statistics. The share of electricity in world total final consumption increased from 9.6% in 1973 to 15.6% in 2001, the biggest increase for all fuels.

In recent years the electricity sector has experienced huge changes. The market for electricity is being liberalised, greenhouse gases need to be reduced; therefore, the increasing role of electricity makes even more necessary the need for precise and reliable data on production, generating capacity as well as on consumption of

electricity in order to manage future development and ensure security of supply in the most efficient way.

Recent blackouts in various parts of the world (Latin and North America, Europe, etc.) underscore the need for reliable, detailed and timely data on electricity.

Specific information related to the joint questionnaire

The questionnaire is designed to collect data on all sources of electricity, public heat and autoproducer heat sold, their consumption and the quantities of fuel used to produce them. The questionnaire also provides for the reporting of electricity-generating capacity and peak annual electricity load.

In order to complete the tables of the questionnaire, it is important to understand that it facilitates reporting of electricity and heat production at several levels. It reflects the **energy source**, the **function** of the producer, and the **plant type**.

The **energy source** refers to the kinetic (e.g. hydro, wind), thermal (e.g. nuclear, geothermal) or combustible fuel used as the input to generate electricity or heat.

There are two **functions** for the producer: i) a *public producer* of electricity or heat is an enterprise which supplies electricity or heat as its main business. The supplier may be publicly or privately owned. And ii) an *autoproducer* of electricity or heat is an enterprise which produces electricity and heat for its own use in support of its main business but not as its main business. The autoproducer may sell some of its output to public supply.

It is important to note that there is often a confusion on the terms “public producer”. A public producer can be owned by a private company, and vice versa a public company can own an autoproducer plant. In other words, public does not apply to the ownership but to the function.

As regards the **plant type**, the questionnaire classifies electricity and heat-generating plants into three types:

- *Electricity-only plants* which generate electricity only.
- *Combined heat and power plants (CHP)* which generate heat and electricity simultaneously.
- *Heat-only plants* which generate heat only.

A CHP plant is one that contains a CHP generating unit. If the plant contains, in addition, an electricity-only or a heat-only unit, the plant should still be considered a CHP plant unless statistics of fuel use and output are available for the individual units. In this case, reporting should be on the basis of the units rather than the plant.

Information is also requested for the electricity-generating plant capacity and peak annual loads.

Essential

The reporting of electricity and heat production is analysed at several levels reflecting energy source, function of producer, and plant type.

2

What Units are Used to Express Electricity and Heat?

General information

Electricity production, consumption and trade are measured and expressed in a multiple of watt-hours. The choice of the multiple (mega, giga, tera, etc.) depends on the size of the quantities produced and consumed.

Heat quantities should be expressed in energy units, usually in a multiple of joules, calories or British thermal units (Btu).

Quantities of combustible fuels consumed for electricity and heat production are expressed in physical units such as metric tons, cubic metres, litres, etc., according to the type of fuel. They also should be expressed in energy units in order to calculate efficiency.

The electricity-generating capacity for the various classes of generating plants is measured and expressed in a multiple of kilowatts. Annual peak load and capacity available at peak are also measured and expressed in a multiple of kilowatts.

Specific information related to the joint questionnaire

The quantities of combustible fuels consumed for electricity and heat production are expressed in physical units, in some cases according to the type of fuel; and in energy units in all cases.

- Solid fossil fuels (coals, peat, etc.) are expressed in 1000 tonnes.
- Manufactured gases are expressed in terajoules (TJ).
- Liquid fossil fuels (oil, refinery gas) are expressed in 1000 tonnes.
- Natural gas and gas-works gas are expressed in terajoules (TJ).
- Renewables and waste are expressed in terajoules (TJ).

The data for generating capacities should be net generating capacities. Net generating capacity is the gross (or “nameplate”) capacity minus the capacity that must be used to operate the auxiliary equipment and transformers within the subject plant.

Essential

The electricity is reported in gigawatt-hours (GWh).

The heat is reported in terajoules (TJ).

The electricity-generating capacity is reported in megawatts (MW).

3 How to Make the Conversion from Volume and Mass to Energy?

General information

Usually the output from the power plants is expressed in energy units, most often in a multiple of kilowatt-hours. However, the inputs to the plant (coal, oil, etc.) are often reported in physical units, respectively tonnes for coal and tonnes or litres for petroleum products.

It is important that the fuel input data are also reported in energy units because they are used to derive plant efficiencies in the data-checking process.

The specific conversions from volume or mass to energy are explained in the chapters related to oil, natural gas, solid fossil fuels and renewables, and in *Annex 3*.

Specific information related to the joint questionnaire

In Table 6, all combustible fuels are also expressed in terajoules (TJ).

In order to convert from physical units to terajoules (TJ), the calorific value per unit is multiplied by the physical units, and further converted to terajoules if necessary. For more information on conversion please refer to Chapter 1, *Fundamentals - Section 5, How to Measure Quantities and Heating Values*, and to *Annex 3 - Units and Conversion Equivalents*."

Energy content of solid and liquid fossil fuels, and of renewables and wastes is expressed in net calorific value (NCV). Energy content of natural gas and manufactured gases is expressed in gross calorific value (GCV). Attention must be given to selecting the correct conversion factor for each input fuel when converting from physical units to energy units.

Essential

The solid fuels, and renewables and wasted products should be reported on a net calorific value basis.

Gases, except biogas, should be reported on a gross calorific value basis.

4 Electricity and Heat Flows

General information

A flow chart from production to consumption for electricity is shown in Figure 2.1. This flow chart is deliberately simplified in order to give an overall view of the supply chain.

Production, trade and consumption are the main elements necessary to have a comprehensive view on the flow of electricity in a country. The details of reporting depend on the use of the information.

Figure 2.1 • Simplified Flow Chart for Electricity

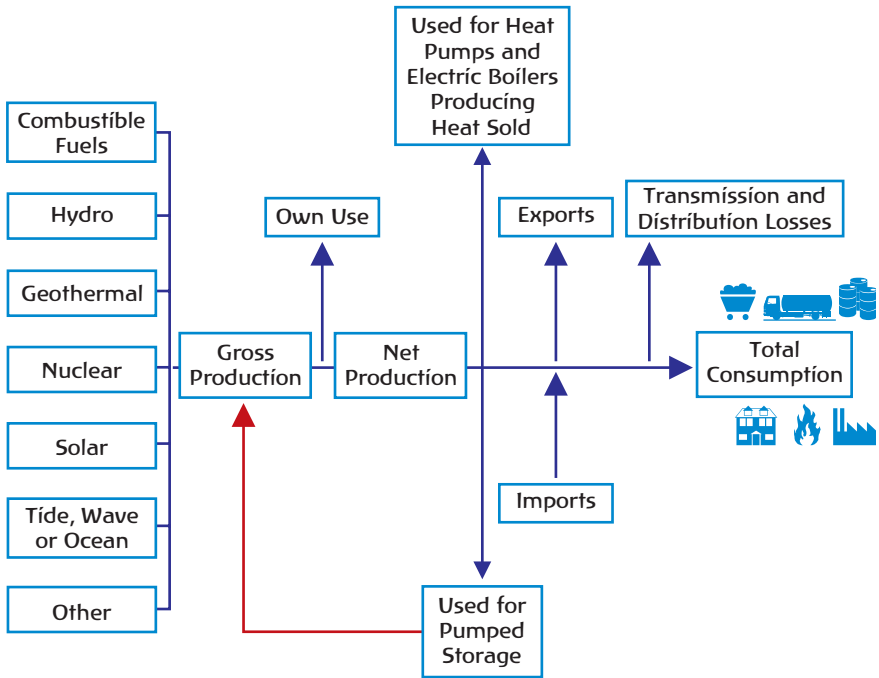
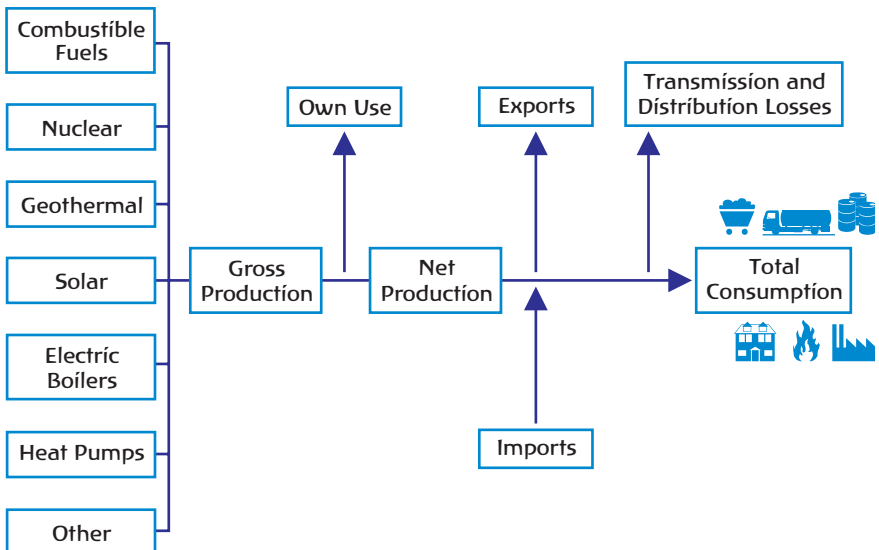

Figure 2.2 • Simplified Flow Chart for Heat



Electricity is produced as a primary or secondary product in power plants; the total amount of electricity produced is called **gross electricity production**. Power plants consume some amount of electricity for own use. **Net electricity production** is obtained by deducting this amount from gross production; this net production is distributed through national transmission and distribution grids to final consumers, or transformed to heat in electric boilers or heat pumps, or stored using pumped storage dams. It can also be exported through international transmission interconnections to another country when an electricity surplus exists; or imported when a shortage exists. During transmission and distribution, some losses occur which are caused by physical characteristics of the grid and the electricity-generating system.

The flow of heat is very much similar to that of electricity with just two exceptions: there is no real possibility to store heat, and heat is transformed into electricity (see Figure 2.2).

Specific information related to the joint questionnaire

The *Electricity and Heat Questionnaire* consists of nine tables, the first four tables following a conventional balance format. The nature of each table is as follows:

- Table 1: Gross Electricity and Heat Production.
- Table 2: Net Electricity and Heat Production.
- Table 3: Electricity and Heat Supply and Consumption.
- Table 4: Electricity and Heat Consumption in Industry and Energy Sectors.
- Table 5: Net Electricity and Heat Production by Autoproducers.
- Table 6: Gross Electricity and Heat Production from Combustible Fuels.
- Table 7a: Net Maximum Electrical Capacity and Peak Load.
- Table 7b: Net Maximum Electrical Capacity of (plant using) Combustible Fuels.
- Table 8: Imports by Origin and Exports by Destination of Electricity and Heat.
- Table 9: Fuel Consumed for Autoproduction of Electricity and Heat.

These tables will be presented in the next paragraphs. However, there are a number of key totals, which must be preserved across the various tables. They are illustrated in the diagrams shown below, Figures 2.3 and 2.4.

The following totals have to be consistent between the various tables:

- The *Production of Electricity from Combustible Fuels* in Table 1 should equal the sum of *Electricity Produced from Combustible Fuels* shown in Table 6.
- *Net Electricity and Heat Production* from autoproducers' plants in Table 2 must equal the corresponding total figures in the two parts of Table 5 *Net Electricity and Heat Production*.
- The figures reported for *Imports* and *Exports* in Table 3 must be identical to the totals for *Imports* and *Exports* reported in Table 8.
- The *Total Net Production* reported in Table 5 must equal the total reported in Table 2.

Essential

Please remember the interrelationships between the tables in the questionnaire. Key totals should be consistent.

Figure 2.3 • Table Relations within the Electricity and Heat Questionnaire

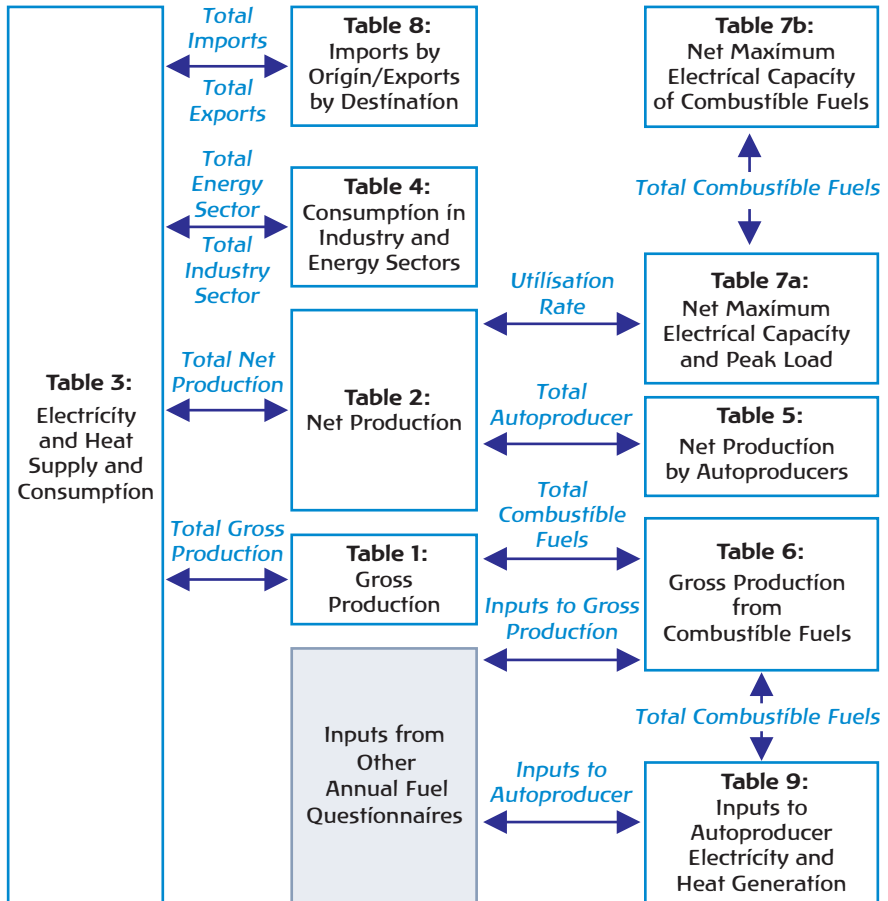

5 Electricity and Heat Supply

Since there are no stocks for electricity and heat, supply only includes production and trade. Each of these two components will be detailed in the next paragraphs.

Production

General information

Electricity and heat are produced from several sources in two basic types of plants, by two types of producers.

To cover all necessary information about production of electricity and heat, production must be viewed from the perspectives described by the questions: "how, where and who?".

The first perspective is the source fuel from which electricity and heat are produced respectively; the sources include coal, petroleum products, natural gas, renewables, etc. The second one is the type of plant; there are two types to consider: electricity-only plant and CHP plant for electricity production, and heat-only plant and CHP plant for heat production. The last perspective is the type of producer; there are two types: public producers and autoproducers.

The data are used for several purposes: assessing security of supply, analysing changes in fuels used for generating electricity over time, the evolution of efficiencies for each fuel, environmental impacts of electricity production, etc.

The major sources for production of electricity and heat are coal (39% of global electricity production), followed by natural gas, nuclear, hydro (each of these fuels accounting for around 17% of global production) and oil (with only 8%). During the past 30 years there have been major changes in fuels used for generating electricity. For instance, the share of oil decreased from 25% to 8%, while the share of nuclear increased from 3% to 17%.

Over the last 30 years, with a 250% increase, electricity production has experienced the fastest growth compared to oil, coal and natural gas. This large increase had to be accompanied by an enormous investment in new capacity, especially of nuclear plants in the 1970s and 1980s.

Specific information related to the joint questionnaire

Production of electricity is reflected in five tables in the questionnaire:

Table 1 provides for reporting a three-level breakdown (fuel, function of producer and plant type) of the **gross production of electricity and heat**.

To complete the table, statistics for gross **electricity** production must be available separately for public electricity producers and autoproducers and the production must be further subdivided according to the type of plant. Gross production of electricity is the total production measured at the output point of the generating machine (alternator) without deduction of electricity used in the plant or lost in other plant equipment.

Electricity produced at hydropower stations should include all electricity produced from pumped storage stations. The amount of electricity produced from pumped storage hydro plants must always be smaller than total electricity produced by hydro plants since this pumped storage electricity is only a part of this number.

Gross production of **heat** is the amount produced and sold. It is the amount of heat leaving the plant for use by persons unrelated to the producer. Similar detail is required for a breakdown of gross heat production. In this case the list of energy sources is slightly different, reflecting the fact that heat is not produced by hydro or tide, wave, ocean facilities, but by heat pumps and electric boilers.

Gross production of geothermal heat is the amount taken from the heat or steam reservoir in the earth's crust. This may be estimated from electricity production in geothermal electricity plants if electricity production is the only use for the heat and no measurements of heat use are available. Where geothermal steam is used for electricity generation, its temperature or pressure may be increased by heating the steam by fuel combustion. It is essential that the heat added should not be included

with the geothermal heat production or with the geothermal heat input to electricity generation. The fuel used should be reported within its own commodity balance as consumption for electricity generation.

Heat pumps are devices for transferring heat from areas with lower ambient temperatures to areas with higher ambient temperatures and are used, for example, to extract heat from a medium outside a building to be used to warm the building's interior. They often use electrically driven motors to perform this function and provide an efficient means of heating in some areas. However, they are not in widespread use and make only a small contribution to national energy supplies.

Electric boilers are used to provide hot water and steam for space heating or other purposes in countries where low-cost electricity (usually hydroelectricity) is available.

Table 2 is identical in format to *Table 1*. Net electricity and heat production are the amounts sent out from the generating plant after use and losses of energy in the plant have been taken into account.

For secondary heat (produced from the combustion of fuels), net production is the amount sold from the plant and is identical to the amount reported for heat in *Table 1*. In other words, for secondary heat the figures for gross and net heat production are identical.

For geothermal heat, net production will differ from gross production if any geothermal heat is used by the plant producing and distributing the heat.

Table 3 is a summary balance of electricity and heat with the main elements of supply and consumption. Data reported should be consistent with other tables where there is a logical relationship (see Section 4 above).

Table 5 provides reporting for net production of electricity and heat by autoproducers in the energy, industry and other sectors.

Electricity statistics are reported in gigawatt-hours (GWh) and heat statistics are reported in terajoules (TJ). All values have to be rounded to zero decimal places and negative values are not allowed.

Table 6a to c provides reporting for the consumption of fuel for gross electricity production and production of heat sold is reported by major fuel categories in a format similar to that used in *Tables 1* and *2*. The corresponding amounts of electricity produced and heat sold are also reported in the table.

When a CHP plant is involved, reporting separate figures for the amounts of fuel used for the production of electricity and heat sold requires a method of dividing the total fuel use between the two energy outputs. The division is required even if no heat is sold because the fuel used for electricity production must be reported in the transformation sector.

In CHP plants, the fuel use must first be divided between the production of electricity and heat. Then the amount of fuel attributed to heat is further divided in proportion to the amount of heat sold to total heat produced. The questionnaire reporting instructions provide a method (reproduced in the box below) for allocating fuel use at CHP plants between the electricity and the heat produced. The method is based on a UNPEDE definition and it should be used only if there is no reliable national method for undertaking this allocation.

Methodology for Allocating Fuel Use at CHP Plants between the Electricity and Heat Produced

The overall efficiency of the CHP process e is defined as:

$$e = (H + E) / F$$

where:

E is the quantity of electricity produced

H is the quantity of heat produced, and

F is the quantity of fuel consumed in the transformation process

The UNIPED definition states that "total heat consumption for the production of electric energy in a combined heat and power station is the heat equivalent of the fuel consumed by the plant less the heat supplied for external purposes when related to the fuel input."

This definition proposes that the imputed fuel used for heat and electricity are:

$$F_h = H / e = F [H / (E + H)] \quad F_e = F - H / e = F [E / (E + H)]$$

In other words, the fuel input is divided between the electricity and heat in proportion to their shares in the output.

Note: The methodology is based on a UNIPED definition and it should be used only if there is no reliable national method for undertaking this allocation.

Figure 2.4 • Simple Diagram Representing the Relationship between the Fuel Input and the Electricity and Heat Produced in a CHP Unit

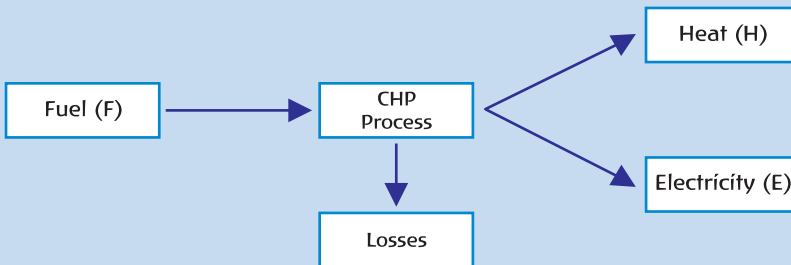

Electricity statistics are reported in gigawatt-hours (GWh) and heat statistics are reported in terajoules (TJ). However, in Table 6, the fuel consumed should be reported in thousand tonnes (10³t) and terajoules for solid and liquid fuels, and in terajoules for gaseous fuels.

All values have to be rounded to zero decimal places and negative values are not allowed.

Essential

All the production data are reported from the perspectives of fuel, function of producer and plant type.

Gross production of heat is the amount of heat produced and sold.

Imports and exports

General information

With increasing globalisation and opening of countries' economies, trade of electricity has been growing. On all continents, countries are connecting their grids in order to improve security of electricity supply and take advantage of generating cost differentials.

Therefore, it is more and more important to collect information about trade disaggregated by countries of origin and destination. These statistics also help in identifying potential transmission congestion and provide means for the most efficient operation of an evolving international transmission grid.

Electricity is transported using high-voltage national transmission grids, which are interconnected at borders. The capacity of these connecting points limits the possible exchange among countries. It is important to note that since it is impossible to store electricity, supply must always equal demand in order to keep the grid in balance. This creates an additional technical burden on transmission grid operators, and further stimulates the need for cross-border electricity flows.

The dynamics of trade is reflected in world import and export statistics. World trade has increased by more than five times over the last 30 years. Moreover, trade, which has often been limited to neighbouring countries in the past, has started to have a much wider dimension such as in Europe where a customer from South Europe can buy electricity from North Europe.

Specific information related to the joint questionnaire

Amounts are considered as imported or exported when they have crossed the national boundaries of the country. Quantities reported should be the physical amounts crossing the national boundary and include transit quantities where applicable. Origins and destinations will therefore be neighbouring countries. This constitutes a major difference with the reporting of trade of most of the other fuels.

Imports and exports of electricity are reflected in two tables in the questionnaire: *Imports by Origin* and *Exports by Destination* are reported in Table 8, and total *Imports* and *Exports* are reported in Table 3.

As regards heat, a similar principle applies for the reporting of heat trade. However, heat trade is rare, and unlikely to involve transit quantities.

Electricity statistics are reported in gigawatt-hours (GWh) and heat statistics are reported in terajoules (TJ). All values have to be rounded to zero decimal places and negative values are not allowed.

Essential

Note that the inclusion of transit quantities of electricity and heat is an exception to the general rule for the reporting of imports and exports.

6 Electricity and Heat Consumption

The consumption of electricity and heat occurs in several sectors:

- In the transformation sector, and by the energy industry within the energy sector.
- In the transmission and distribution of electricity and heat.
- In the various sectors and branches of final consumption (industry, transport, residential, services, etc.).

A short description of these sectors is given in the next paragraphs, highlighting the impact of the specificity of the sector end-use on statistics.

Consumption of electricity and heat in the transformation and energy sectors

General information

Electricity is transformed only to heat using heat pumps or electric boilers. Heat has no transformation sector.

Electricity and heat are also used in the energy sector supporting the extraction and production of fuels and transformation activities. Pumped storage plants are also part of this category. In these plants, electricity is used to pump the water to the reservoirs during low load periods, while during peak load periods flows from the water reservoirs are used to generate electricity.

The transformation and energy sectors consume around 10% of global electricity supply and around 9 % of global heat supply.

Specific information related to the joint questionnaire

The transformation and energy sectors are reflected in Tables 3 and 4 of the questionnaire.

Consumption of electricity and heat in the nuclear industry refers to the production and enrichment of nuclear fuels. It does not include electricity and heat consumed during the operation of nuclear power stations. Electricity and heat used in nuclear power stations is reported as *Own Use by Plant* in Table 3.

Electricity statistics are reported in gigawatt-hours (GWh) and heat statistics are reported in terajoules (TJ). All values have to be rounded to zero decimal places and negative values are not allowed.

Essential

The consumption of electricity in the transformation sector is limited to heat pumps and electric boilers. There is none for heat.

Consumption in the nuclear industry refers to the enrichment of nuclear fuel, not to own use at nuclear power plants.

Electricity and heat transmission and distribution losses

General information

Transmission and distribution losses are all losses due to transport and distribution of electricity and heat. For electricity, losses in transformers which are not considered as integral part of the power plant are also included.

For electricity, the distribution losses account for anywhere from 7% to 15% of electricity supply. The amount of losses is mainly dependent on the size of the country (length of power lines), voltage of transmission and distribution and quality of network. In some countries, theft may be a large part of losses; this is sometimes called non-technical losses.

For heat, distribution losses account for about 15%. The heat is usually distributed only over short distances, otherwise it becomes inefficient.

Specific information related to the joint questionnaire

Transmission and distribution losses are reflected in Table 3.

Electrical losses in overhead transmission lines and distribution networks are reported on the row *Transmission and Distribution Losses*. Equally, losses of heat during distribution to distant consumers should be reported on the same row.

Figures for electrical losses should be obtained from national grid operating companies and electricity distribution companies. Losses of heat should be obtained from the district heating companies and other heat sellers. Losses of electricity or heat should not be estimated by statisticians to make the supply and consumption balance.

Electricity statistics are reported in gigawatt-hours (GWh) and heat statistics in terajoules (TJ). All values have to be rounded to zero decimal places and negative values are not allowed.

■ **Essential**

All quantities of electricity and heat lost during transportation and distribution should be reported under transmission and distribution losses.

Final Consumption

General information

The final consumption of electricity and heat is all electricity and heat consumed in industry, transport, agriculture, commercial/public services and residential sectors. These sectors are broken down in accordance with the ISIC classification.

The final consumption is a major part of the electricity and heat consumption, accounting for about 80% of total consumption. It is also the most dynamic part of

the consumption. Much of the growth in electricity consumption since 1973 has taken place in residential and commercial/public sectors. The share of the residential and commercial/public service sectors combined increased from about 38% to 52% over the last 30 years.

Although the amount of electricity consumed in the industry sector has constantly increased, it has increased at a slower rate than in the residential and commercial/public sectors. Consequently, the share of industry has decreased from 51% in 1973 to currently around 42%.

The transport (rail) and agriculture (mainly irrigation pumps) sectors are relatively small consumers of electricity.

Specific information related to the joint questionnaire

The aggregate number for the *Industry Sector* is reported in Table 3 as well as for other sectors such as *Residential, Commercial and Public Services, Agriculture* and others. As regards the *Transport Sector*, consumption should be reported for total transport as well as broken down between *Rail, Pipeline transport and Non-specified*.

Because of the importance of electricity in the industry sector, consumption of electricity is further disaggregated by sub-sectors in Table 4. There is no provision for the reporting of electricity for non-energy use as all electricity consumption is considered to be for energy use.

Electricity statistics are reported in gigawatt-hours (GWh) and heat statistics in terajoules (TJ). All values have to be rounded to zero decimal places and negative values are not allowed.

Essential

The final consumption of electricity and heat is the sum of electricity and heat consumed in industry, transport, agriculture, commercial/public services and residential sectors.

There is no provision for reporting non-energy use of electricity and heat.

7 Additional Requirements for the Joint Questionnaire on Electricity and Heat

Inputs to autoproduction.....

General Information

With the growing importance of the environmental debate, it has become essential to identify total consumption of fuels in each respective industry and consuming sector, so that for each sector appropriate measures can be developed to conserve energy and reduce greenhouse gas emissions.

For general information and definitions for autoproduction, please refer to Section 1, *Specific information related to the joint questionnaire*.

Specific information related to the joint questionnaire

Inputs to autoproducer electricity and heat production are reported on the two parts of Table 5.

These tables provide information on the fuel used by autoproducers of electricity and heat for sale according to their principal economic activity. The table is separated into columns corresponding to three recognised types of generating plant: *Electricity-only*, *CHP*, and *Heat-only*. The data are used for tracking fuel inputs and electricity and heat outputs by autoproducers as part of the United Nations efforts to understand CO₂ emissions.

In the case of CHP plants, reporting separate figures for the amounts of fuel used for the production of electricity and heat requires a method of dividing the total fuel used between the two energy outputs. The division is required even if no heat is sold because the fuel used for electricity production must be reported in the transformation sector. The method proposed is described in Annex 1, Section 1 and should be followed carefully.

Please note that the totals reported in this table should equal the respective totals reported in the *Transformation Sector* (Table 1). Also note that a similar table is included with the other four annual questionnaires. To avoid inconsistent reporting, please contact the person responsible for the completion of the other questionnaires in your country.

Essential

Similar tables are included with the other fuel questionnaires (coal, oil, natural gas and renewables and waste).

Net maximum electrical capacity and peak load.....

General information

Net electrical capacity, peak load and date of peak load occurrence are monitored to measure energy security-related factors like reserve margin, capacity available during load peaking periods, etc.

The net maximum capacity is the maximum power that can be supplied, continuously, with all of the plant running, at the point of outlet to the network (*i.e.* after taking the power supplies for the station auxiliaries and allowing for the losses in those transformers considered integral to the station).

The national **maximum electricity-generating capacity** is defined as the sum of all individual plants' maximum capacities available during a period of at least 15 hours per day. The reported figures should relate to the maximum capacities on 31 December and be expressed in megawatts (MW).

Data on fuel firing capability are important inputs into planning responses to national and international fuel disruptions.

The **peak load** is the highest simultaneous demand for electricity satisfied during the year. Note that the electricity supply at the time of peak demand may include demand satisfied by imported electricity or alternatively the demand may include exports of electricity.

Total peak load on the national grid is not the sum of the peak loads during the year on every power station as they may occur at different times.

The capacity at time of peak is the total available net capacity at that time and may differ from the maximum available capacity reported above because of plant maintenance or other outages at the time of peak load.

Specific information related to the joint questionnaire

This information is collected in Table 7 of the questionnaire which is divided in two: Tables 7a and 7b.

- Table 7a collects information on *Net Maximum Electrical Capacities and Peak Load*. The table requires that the total national capacity be divided between public electricity suppliers and autoproducers, and also by energy source. The capacity reported under *Combustible Fuels* is further divided according to the technology of the generating plant.
- Table 7b collects information on *Net Maximum Electrical Capacities of Plants Using Combustible Fuels*. The total net maximum capacity reported under *Combustible Fuels* in Table 7a, subdivided by public/autoproducer, is further subdivided by fuel firing capability in Table 7b. Firing capability is separated into "single" fuel and "multiple" fuel categories. A multi-fired plant is one that contains single units that can burn several fuels on a continuous basis.

Electrical capacities are reported in megawatts (MW). All values have to be rounded to zero decimal places and negative values are not allowed.

Essential

The reported figures should relate to the maximum capacities on 31 December and be expressed in megawatts (MW).

Natural Gas



1 What is Natural Gas ?

General information

Natural gas comprises several gases, but consists mainly of **methane** (CH₄).

As its name suggests, natural gas is taken from natural underground reserves and is not a chemically unique product. When extracted from a gas field or in association with crude oil, it comprises a mixture of gases and liquids (some of them will not be energy commodities). Only after processing does it become one of the marketable gases among the original mixture. At this stage natural gas is still a mixture of gases but the methane content predominates (typically greater than 85%).

Natural gas which is produced in association with oil is called **associated gas**, whereas production from a gas reservoir not associated with oil is **non-associated gas**.

When mining for coal in underground mines, some gas can be released from the coal deposit. This gas is called **colliery gas** or **colliery methane**. This gas must be removed for safety reasons, and where this is collected and used as a fuel, the amounts involved should be included in marketed production.

The terms **wet** and **dry gas** are also frequently used. When a gas contains an appreciable quantity of butane and heavier hydrocarbons (natural gas liquids – NGL), it is said to be a **wet gas**. Natural gas produced in association with oil – or associated gas – is usually wet gas. **Dry gas** consists mainly of methane with relatively small amounts of ethane, propane, etc. Non-associated gas, *i.e.* produced from a gas well not associated with oil, is usually dry gas.

To facilitate transportation over long distances, natural gas may be converted to liquid form by reducing its temperature to –160 degrees Celsius under atmospheric pressure. When gas is liquefied, it is called **liquefied natural gas (LNG)**. Gas liquefaction changes only the physical state of natural gas from gas to liquid, it remains primarily methane, that is why it should be included in the *Natural Gas Questionnaire*. For more information, see *Annex 1, Section 4*.

Natural gas supply and demand are growing fast. Natural gas now accounts for more than 21% of global total primary energy supply, compared to 16.2% in 1973.

Specific information related to the joint questionnaire

In the *Natural Gas Questionnaire*, production of natural gas, separated into associated and non-associated gas, needs to be reported. Additionally, colliery methane recovered from coal mines needs to be included. Manufactured gases, such as gas-works gas, and liquid gases, such as natural gas liquids (NGL) and liquefied petroleum gases (LPG), should not be included in the *Natural Gas Questionnaire*, but reported respectively in the *Coal* or *Oil Questionnaire*.

Essential

Natural gas consists mainly of methane.

Colliery gas needs to be included.

2 What Units are Used to Express Natural Gas?

General information

Natural gas can be measured in several units: either according to **energy content** (also referred to as heat) or **volume**.

Within each of these measurements, several units are used in the natural gas industry:

- In order to measure **energy**, it is possible to use joules, calories, kWh, British thermal units (Btu), or therms.
- In order to measure **volume**, the most frequently used unit is the cubic metre or the cubic foot.

When using volume measurements for natural gas, it is important to know at which temperature and under which pressure the gas has been measured. Indeed, as gas is very compressible, volumes of gas have meaning only at an agreed specific temperature and pressure. There are two sets of conditions under which gas can be measured:

- Normal conditions: measured at a temperature of 0 degrees Celsius and a pressure of 760 mm Hg.
- Standard conditions: measured at a temperature of 15 degrees Celsius and a pressure of 760 mm Hg.

For more detailed information please refer to *Annex 1*, Section 4.

Specific information related to the joint questionnaire

In the *Natural Gas Questionnaire*, the supply balance and trade data are to be reported in both energy units and volume units. The energy unit used is the **terajoule (TJ)**, the volume unit is **million cubic metres (Mm³)**. The conditions used are the **standard conditions** (i.e. at 15 degrees Celsius and 760 mm Hg). Data are to be reported in gross calorific value.

Furthermore, gross and net calorific value data for the flows on the supply balance are to be stated.

The consumption and the inputs to autoproducers data are only reported in energy units: terajoules (TJ).

Essential

Natural gas data are reported in two units:

- **a unit of energy, the terajoule (TJ), and**
- **a unit of volume, million cubic metres (Mm³).**

3 How to Make the Conversion from Volume to Energy?

General information

The most common method of metering and accounting for gas is by volume (e.g. Mm³). However, natural gas prices are often determined on the basis of the calorific content per volume unit, as gas is purchased for its heating value.

The calorific value of natural gas is the amount of heat released by the complete combustion of a unit quantity of fuel under specified conditions, e.g. kcal/m³, or megajoule (MJ/m³). Values may be quoted either **gross** or **net**. The difference between **gross and net calorific value** is the latent heat of vaporisation of the water vapour produced during combustion of the fuel. For natural gas, the net calorific value is on average 10% less than the gross value.

For general information on conversion, please refer to Chapter 1, *Fundamentals – How to Measure Quantities and Heating Values* (Section 5), and Annex 3 – *Units and Conversion Equivalents*.

Specific information related to the joint questionnaire

The **conversion to energy units** (TJ) must be done using the gross calorific value of the flow concerned. Each of the gas flows may have a different calorific value, and within each flow, the components might have different values (e.g. production from various fields of differing gas qualities, or imports from different sources). Calorific values also change over time. The relevant gross calorific values may be obtained from the gas supply industry.

To convert natural gas from volume units to terajoules, use the appropriate gross calorific value for each of the components of the different flows. The volume, in cubic metres, should be multiplied by the gross calorific value to obtain the energy volume in terajoules.

Concerning import data, a weighted average gross calorific value should be applied. In other words, total imports should be the sum of each of the sources individually converted. For example, country A is importing 3 000 Mm³ natural gas from the Netherlands and 5 000 Mm³ from Norway, with a respective calorific value of 33.3 TJ/m³ and 41.0 TJ/m³. To calculate the average calorific value of imports, proportion the respective imports with their calorific values, as shown in the following table:

Table 3.1 • How to Calculate the Average Calorific Value of Imports

From	Imports (Mm ³)	Calorific Value (TJ/m ³)	Imports in Terajoules (m ³ x TJ/m ³)	Calorific Value (TJ/m ³)
Netherlands	3 000	33.3	3 000 x 33.3 = 99 900	
Norway	5 000	41.0	5 000 x 41.0 = 205 000	
Total	8 000	?	99 900 + 205 000 = 304 900	304 900 / 8 000 = 38.113

From the above calculation it is derived that the average conversion factor for country A's imports is 38.113 TJ/m³, to be reported in the questionnaire as 38 113 KJ/m³.

Essential

Report natural gas in gross calorific values, using specific calorific values when available.

4 Natural Gas Flows

General Information

A flow chart from production to consumption for natural gas is shown on the diagram below, Figure 3.1. This flow chart is voluntarily simplified in order to give an overall view of the supply chain.

Production, trade, stocks, energy sector, transformation and final consumption are the main elements to be known in order to have a comprehensive view on the flow of gas in a country. The details in reporting depend on the use of the information.

Figure 3.1 • Simplified Flow Chart for Natural Gas

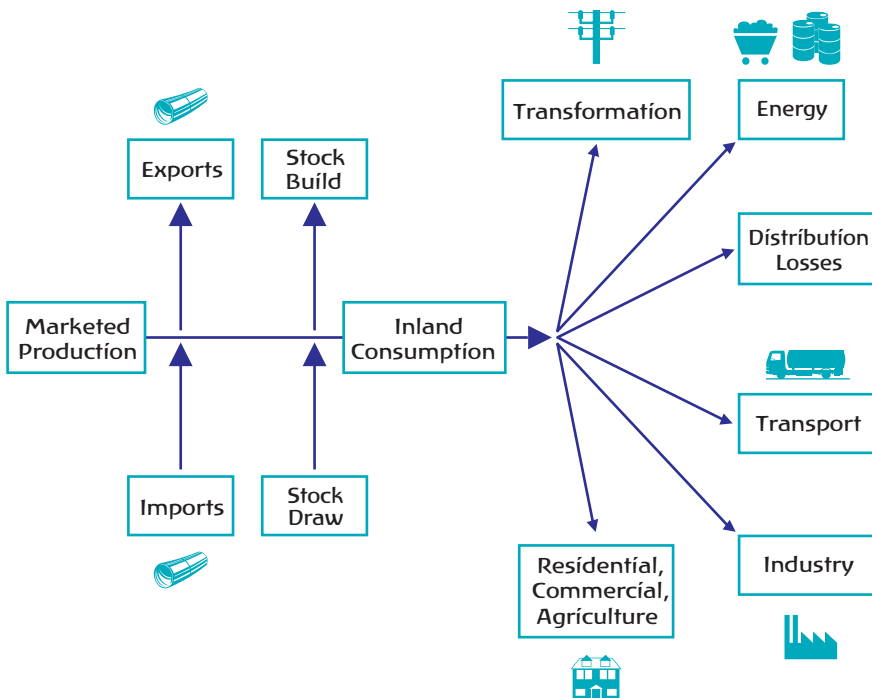

Specific information related to the joint questionnaire

The *Natural Gas Questionnaire* structure follows the flow chart of Figure 3.1. The questionnaire contains five tables:

- Table 1: Supply of Natural Gas (see Section 5).
- Tables 2a, 2b: Consumption by Sector (see Section 6).
- Table 3: Imports by Origin (see Section 5).
- Table 4: Exports by Destination (see Section 5).
- Table 5: Inputs to Autoproducer Electricity and Heat Generation (see Section 7).

Each of the above tables will be presented in the next paragraphs. However, there are a number of key totals which must be preserved across the various tables. These are illustrated in Figure 3.2.

Figure 3.2 • Table Relations within the Natural Gas Questionnaire

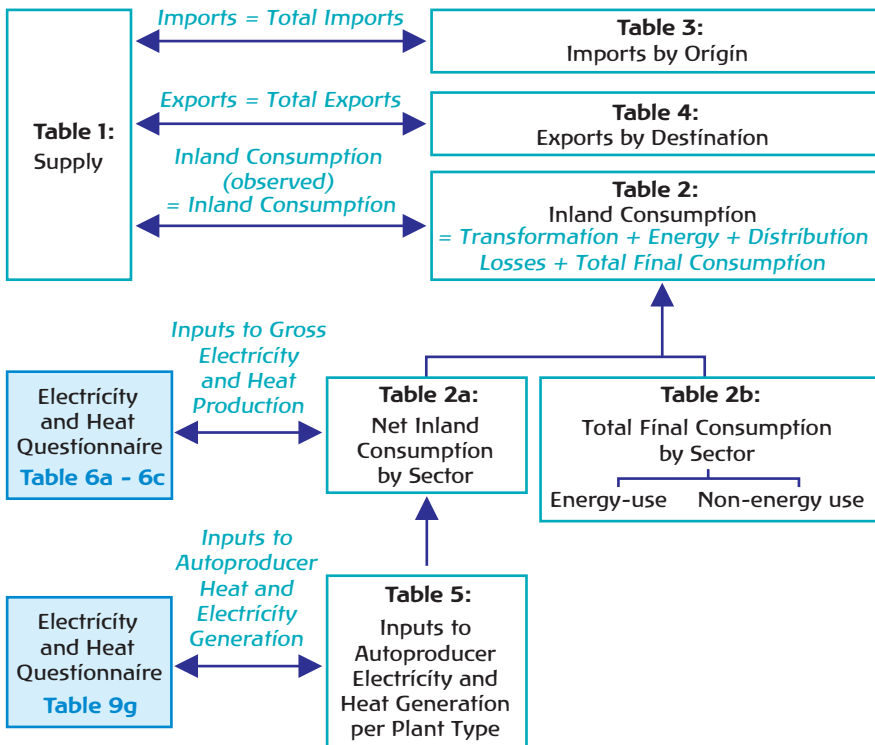

The following totals have to be consistent between the various tables:

- *Imports by Origin* in Table 3 should be summed, and the sum should be reported under *Total Imports* in Table 1.
- *Exports by Destination* in Table 4 should be summed, and the sum should be reported under *Total Exports* in Table 1.

- *Inland Consumption (observed)* in terajoules in Table 1 should correspond to *Inland Consumption* in terajoules in Table 2.
- *Inland Consumption* in Table 2a is the sum of Transformation Sector, Energy Sector, Distribution Losses, plus Total Final Consumption (Energy Use + Non-Energy Use) in Table 2b.
- *Autoproducer Electricity Plants* data in Table 2a should correspond to *Total Input* of Autoproducer Electricity Plants in Table 5.
- *Autoproducer CHP Plants* data in Table 2a should correspond to *Total Input* of Autoproducer CHP Plants in Table 5.
- *Autoproducer Heat Plants* data in Table 2a should correspond to *Total Input* of Autoproducer Heat Plants in Table 5.

Essential

Please remember the interrelationships between the tables in the questionnaire. Key totals should be consistent.

5 Natural Gas Supply

As defined in Chapter 1, *Fundamentals*, Section 9, supply includes production, trade and stock changes. Each of these three components will be detailed hereunder.

Production

General information

Natural gas, as extracted, is subject to several possible treatments, depending on the circumstances of its production, before it becomes marketable. The various processes are illustrated in Figure 3.3. For sake of clarity, readers who would like to know more about some of the processes can find more detailed information in Annex 1.

Specific information related to the joint questionnaire

Indigenous Production is to be reported in Table 1 (Supply).

It is obvious from the flow chart in Figure 3.3 that it is not always simple to draw the statistical boundary between flows which are to be included in the statistics and those which are not. However, for the purpose of the *Natural Gas Questionnaire*, what is reported as *Indigenous Production* should be **marketed production**, measured after purification and extraction of any NGLs and sulphur.

However, it is essential to remember that:

- The *Associated Gas* from the extraction of crude oil should be reported in the *Natural Gas Questionnaire* (Table 1).

Figure 3.3 • Simplified Flow Chart for Natural Gas Production

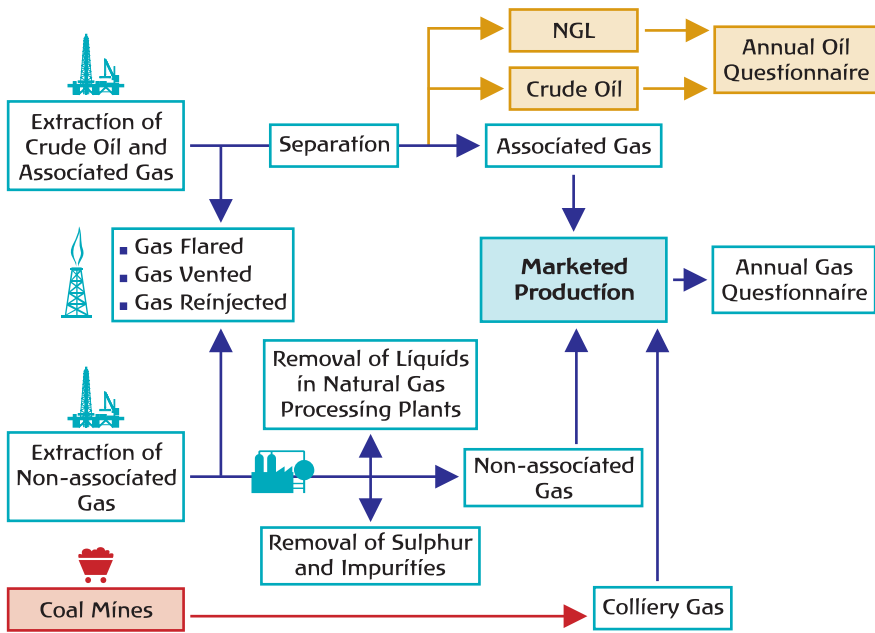

- Gas vented, flared or reinjected should not be included. However, figures for vented and flared gas are required by environmental agencies for estimates of fugitive emissions from oil and gas production activities. This is why they need to be reported separately.
- Quantities of gas used within the natural gas industry (often in non-marketable state) in the various separation and treatment processes should be included in the production data.

The production data are to be reported in both energy units (TJ) and volume units (Mm³). Values should be rounded to zero decimal places and negative values are not allowed.

Essential

Indigenous production should be the marketed production and should exclude gas that is vented, flared or reinjected, but include quantities used in the processing plants.

Imports and exports

General information

There are two main means of transport of natural gas: in a gaseous form by gas pipeline, and in a liquid form by LNG carriers.

Because of the relative difficulty and high cost for transporting natural gas, trade of gas remained limited until recently. In 1971, the gas traded accounted for 5.5% of total natural gas consumed. However, in the last decades natural gas trade experienced a fast development and is now representing more than one-quarter of all gas consumed.

Moreover, if in the past the gas market was essentially local, the development of more efficient gas pipeline technologies has made the market more regional (for instance Europe, North America). The development of gas fields far from consumption regions and the expansion of the spot market will soon make the gas market more global.

As a consequence, because of the growing role of natural gas in the energy market, it is essential to have detailed and reliable data on gas imports and exports. However, the reporting of the origins and destinations for gas trade is sometimes complicated by the fact that natural gas is often transported through pipelines which may cross many territorial boundaries.

Specific information related to the joint questionnaire

Total *Imports* and *Exports* are to be reported in Table 1. *Imports by Origin* and *Exports by Destination* are to be reported respectively in Tables 3 and 4.

For purposes of energy security, origins and destinations of natural gas are an important part of the data collection.

For imports, it is important to know (therefore to report) the ultimate origin of the gas (the country in which it is produced), while for exports it is essential to show the ultimate destination (the country in which the gas will be consumed) of domestically produced gas. The companies responsible for the commercial arrangements leading to the trade should be able to provide the data.

Imports concern gas which is to be consumed within the country, and exports concern gas which has been domestically produced. Transit trade and re-exports are therefore not to be included in the trade reported.

The trade data are to be reported in both energy units (TJ) and volume units (Mm³). Values should be rounded to zero decimal places and negative values are not allowed.

Essential

Imports should cover gas entering your country for domestic consumption, and reported under the country where the gas was produced.

Exports should be domestically produced gas leaving your country, and reported under the country where the gas will be consumed.

Transit trade and re-exports are therefore not to be included.

Stock levels and changes

General information

Natural gas demand is very seasonal in most countries; in the winter, demand for gas often places strains on the transmission and distribution systems. To limit the need for long-distance gas transport, many countries have started to build gas storage facilities. Additionally, strategic reserves of gas improve the security of gas supplies.

As in the case of oil, timely, detailed and accurate data on the levels and the changes in stocks are becoming essential for policy-makers and market analysts, especially at a time when the share of natural gas is increasing in total energy supply.

Gas storage facilities fall into two basic categories, which define their characteristics: seasonal or peak. Seasonal storage sites, which may also serve a strategic purpose, must be able to store huge volumes of gas built up during low demand times for slow release during periods of high demand. Peak facilities store smaller quantities but must be able to inject gas quickly into the transmission network to meet surges in demand. The different storage facilities can be classified according to physical type (for more information, see *Annex 1*). Among the most frequently used ones are: aquifers (including depleted oil/gasfields), salt caverns, LNG peak-shaving units, mined caverns, disused mines and gasholders.

Gas storage and stocks are to be distinguished from **gas reserves**. The former refer to gas already produced, but used for strategic, seasonal or peak-shaving purposes. The term **gas reserves** refers to estimated quantities of gas not yet produced, but which analysis of geological data demonstrates with reasonable certainty to be recoverable in future years from known oil and gas reservoirs.

Specific information related to the joint questionnaire

Natural gas stock levels and stock changes are to be reported in Table 1 (Supply).

Both opening and closing stock levels need to be reported. *Opening Stocks* are the stock levels as of the first day of the time period requested; *Closing Stocks* are the stock levels at the end of the time period. For example for a calendar year, opening stocks are the stock levels on 1 January, closing stocks are measured on 31 December.

The *Natural Gas Questionnaire* asks for details on gas storage of recoverable gas. Stock level changes are related to changes in recoverable gas. (Stock change is equal to opening stocks minus closing stocks, i.e. a negative number indicates a stock build, a positive number indicates a stock draw.)

Underground storage reservoirs contain “cushion gas”, which may be considered unavailable, but is there to maintain the operational performance of the reservoir. As a consequence, the stock level of the *Cushion Gas* is requested separately for information.

The stocks data are to be reported in both energy units (TJ) and volume units (Mm³).

Essential

Report stock levels and changes of recoverable gas in the main supply table, and cushion gas separately as a memo item for information.

Stock changes are calculated as the opening level minus the closing level.

6 Natural Gas Consumption

The consumption of natural gas occurs in several sectors:

- In the transformation sector.
- By the energy-producing industry within the energy sector.
- In the transport and distribution of gas.
- In the various sectors and branches of final consumption (industry, transport, residential, services, etc.). This includes both energy and non-energy uses of natural gas.

A short description of these four sectors is given in the next paragraphs, highlighting the impact of the specificity of the sector end-use on statistics. For general information refer to Chapter 1, *Fundamentals*, Section 8.

Consumption of natural gas in the transformation sector

General information

The perception of natural gas today is radically different from what it was 10 or 20 years ago. In the past, natural gas was perceived as a noble fuel, reserved for premium uses, therefore not often consumed in the transformation sector. Today it is used in a variety of sectors and applications, and it is experiencing significant growth as a fuel for power generation. Enhancement of gas turbine technology has substantially improved the position of gas in power generation, both for combined-cycle gas turbine (CCGT) generators and combined heat and power (CHP) plants. Gas offers many advantages in this sector compared with other fossil fuels: high efficiency, relatively low capital costs, and cleanliness. Gas is the cleanest fuel among fossil fuels and its demand will be favoured for environmental reasons.

In recent years, natural gas consumed for electricity generation has accounted for almost 20% of global electricity production (up from 13% in 1973), and accounts for approximately half of the world production of heat generated in CHP and heat plants.

Specific information related to the joint questionnaire

The *Transformation Sector* includes statistics of electricity and heat generation according to the type of plant (i.e. electricity-only, heat-only or combined electricity and heat) as well as the separation between type of producer (i.e. public and autoproducer). For more information on these various categories, please refer to *Annex 1, Section 1*.

Natural gas used as feedstock for conversion to liquids, e.g. methanol production, should be reported in the transformation sub-sector: *Conversion to Liquids* (Table 2a). The output of natural gas liquids should be reported in the *Oil Questionnaire* (Table 1) under *Other Sources*.

Essential

Report in the transformation sector inputs of energy which are transformed into other forms of energy.

Consumption of natural gas in the energy sector.....

General information

The consumption of the energy sector includes "own use". This includes natural gas consumed by the energy industry to support the extraction (mining, oil and gas production) or the transformation activity (for example natural gas consumed for heating, or operating pumps or compressors).

Specific information related to the joint questionnaire

Within the *Energy Sector*, the sub-sectors are the various energy-producing industries. Moreover, special for natural gas is the sub-sector *Liquefaction Plants*.

For the *Liquefaction Plants*, report in this sub-sector the amounts of gas used as "own use" to liquefy natural gas. This often can only be measured by the difference between natural gas inputs into the liquefaction plant and LNG output (but will include some losses in energy). Although gas is being transformed from a gaseous state to a liquid form by cooling it (to -160 degrees Celsius), there is no change in the composition of the methane. This is why the liquefaction process is not reported in the transformation sector. The energy used for the liquefaction process is reported as consumption of the *Energy Sector* (sub-sector *Gas Liquefaction Plants*).

Essential

The energy sector includes energy used in support of the extraction and transformation activities.

Natural gas transport and distribution losses.....

General information

As natural gas is often piped over long distances, some losses may occur.

When referring to transport and distribution losses, it is usually understood that **transport** losses are those that occur during the transmission of gas over a long distance, while **distribution** losses are those that happen in the gas supply chain through the local distribution network.

These losses may be due to differences in measurement, such as differences in metre calibrations of the flows or differences in temperature and pressure at the moment of measurement. Moreover, there may be smaller or larger leaks in pipelines.

All these differences can be classified as losses during the transport and distribution of the natural gas from production to consumption point, or transport and distribution losses. For information, those losses account for less than 1% in global gas supply, although the percentage can obviously vary substantially between countries.

Specific information related to the joint questionnaire

The category *Distribution Losses* (Table 2a) should include all losses which occur during transport and distribution of the gas, including pipeline losses.

Gas used by pipeline compressors to transport the gas in the pipeline should be reported as part of the *Transport Sector* consumption (Table 2b).

Essential

Losses which occur during transportation should be included in distribution losses.

Gas used for operating the pipelines should be included in the transport sector (pipeline transport) and not in gas transport and distribution losses.

Final consumption.....

General information

Final consumption is all energy delivered to final consumers in the **transport**, **industry** and **other sectors**. It excludes gas used for transformation and/or own use of the energy-producing industries. The branches of the three main sectors are discussed in Chapter 1, *Fundamentals*, Section 8.

In the **transport** sector, natural gas is used in a compressed form (compressed natural gas or CNG) or in liquefied form (LNG). CNG is natural gas for use in

special CNG vehicles, where it is stored in high-pressure fuel cylinders. CNG's use stems in part from its clean burning properties, as it produces fewer exhaust and greenhouse gas emissions than motor gasoline or diesel oil. It is used most frequently in light-duty passenger vehicles and pickup trucks, medium-duty delivery trucks, and in transit and school buses. LNG, on the other hand, is favoured for heavy-duty applications, such as transit buses, train locomotives and long-haul semi-trucks. The requirement of keeping the LNG very cold, along with its volatility, makes its applications more limited for transportation purposes.

Data are collected for energy and non-energy (feedstock) use of natural gas in the sectors and branches of final consumption. The most important use as feedstock will be in the **chemical and petrochemical industry**.

Methane in natural gas is an important source of carbon and hydrogen for several industrial processes in the chemical industry. The most widely known use is for the manufacture of ammonia, which is used for agricultural fertiliser production. However, methane may also be used for the manufacture of methanol and carbon black. Each of these processes has its own heat requirements, which may be obtained by burning some of the natural gas.

When methane is used as a fuel for petrochemical processes such as steam cracking, ammonia production and methanol production, then it is considered energy use.

However, when it is used as a feedstock in processes such as cracking and reforming for the purpose of producing ethylene, propylene, butylene, aromatics, butadiene and other non-energy hydrocarbon-based raw materials, then it is deemed to be non-energy use.

For information, natural gas represents roughly 16% of global final energy consumption. The shares between energy and non-energy use can vary significantly between countries, depending on the size of the petrochemical industry activity.

Specific information related to the joint questionnaire

It is often difficult to obtain the amount of natural gas supplied for fuel purposes when the gas is delivered to the petrochemical industry. The suppliers of gas to the petrochemical industry may classify all delivered gas as for feedstock use. In this case, it might be better to simplify reporting from the industry, and obtain more accurate data from the chemicals and petrochemicals branch of the industry sector. They are in a much better position to provide the information on the use of natural gas for heat-raising or other fuel purposes.

Essential

***Gas can be used for energy and non-energy purposes.
Report both uses in the appropriate sector.***

7 Additional Requirements for the Joint Questionnaire on Natural Gas

Inputs to autoproduction.....

General information

With the growing importance of the environmental debate, it has become essential to identify total consumption of fuels in each respective industry and consuming sector, so that for each sector appropriate measures can be developed to conserve energy and reduce greenhouse gas emissions.

For general information and definitions for autoproduction, please refer to Chapter 2, *Electricity & Heat*, Section 1.

Specific information related to the joint questionnaire

Inputs to *Autoproducer Electricity and Heat Generation* are reported on Table 5.

This table provides information on the fuel use by autoproducers of electricity and heat for sale according to their principal economic activity. The table is separated into three columns corresponding to three recognised types of generating plant: *Electricity-only*, *CHP*, and *Heat-only*. The data are used for tracking fuel inputs and electricity and heat outputs by autoproducers as part of the United Nations efforts to understand CO₂ emissions.

In the case of CHP plants, reporting **separate** figures for the amounts of fuel used for the production of electricity and heat requires a method of dividing the total fuel use between the two energy outputs. The division is required even if no heat is sold because the fuel use for electricity production must be reported in the *Transformation Sector*. The method proposed is described in *Annex 1, Section 1* and should be followed carefully.

Please note that the totals reported in this table should equal the respective totals reported in the *Transformation Sector*. Also note that a similar table is included in the *Electricity and Heat Questionnaire*. To avoid inconsistent reporting, please contact the person responsible for the completion of the *Electricity Questionnaire* in your country.

Essential

Report natural gas used by autoproducers as input for electricity and heat production in the respective sectors.

Oil



1 What is Oil ?

General information

Petroleum is a complex mixture of liquid hydrocarbons, chemical compounds containing hydrogen and carbon, occurring naturally in underground reservoirs in sedimentary rock. Coming from the Latin *petra*, meaning rock, and *oleum*, meaning oil, the word “petroleum” is often interchanged with the word “oil”. Broadly defined, it includes both primary (unrefined) and secondary (refined) products.

Crude oil is the most important oil from which **petroleum products** are manufactured but several other feedstock oils are also used to make oil products. There is a wide range of petroleum products manufactured from crude oil. Many are for specific purposes, for example motor gasoline or lubricants; others are for general heat-raising needs, such as gas oil or fuel oil.

The names of the petroleum products are those generally used in Western Europe and North America. They are commonly used in international trade but are not always identical to those employed in local markets. In addition to these oils, there are others which are “unfinished” oils and will be processed further in refineries or elsewhere.

Oil supply and use in industrialised economies are complex and involve both energy use and non-energy use. As a result, the indications of use given below can only be guides to general practice and not rigid rules. *Annex 1* provides full explanations of the processes and activities mentioned within the questionnaire.

Oil is the largest traded commodity worldwide, either through crude oil or through refined products. As a consequence, it is essential to collect data as complete, accurate and timely as possible on all oil flows and products. Although oil supply continues to grow in absolute terms, its share in global total energy supply has been decreasing, from over 45% in 1973 to around 35% in recent years.

Specific information related to the joint questionnaire

The *Oil Questionnaire* covers oils processed in refineries and the petroleum products made from them. All sources of supply and the uses of the oils are to be included as well as their calorific values.

Crude oil is not the only feedstock to a refinery. Other primary or secondary oils can be used as feedstock: NGL, refinery feedstocks, additives and oxygenates and other hydrocarbons such as shale oil or synthetic crude oil from tar sands (see Table 4.1).

A whole range of petroleum products are derived from crude oil, varying from light products such as liquefied petroleum gas (LPG) and motor gasoline to heavier ones such as fuel oil.

Table 4.1 • Primary versus Secondary Oil

PRIMARY OIL PRODUCTS	Crude oil	
	Natural gas liquids	
	Other hydrocarbons	
SECONDARY PRODUCTS INPUTS TO REFINERY	Additives/blending components	
	Refinery feedstocks	
SECONDARY OIL PRODUCTS	Refinery gas	Transport diesel
	Ethane	Heating and other gasoil
	Liquefied petroleum gases	Res. fuel: low-sulphur content
	Naphtha	Res. fuel: high-sulphur content
	Aviation gasoline	White spirit + SBP
	Gasoline type jet fuel	Lubricants
	Unleaded gasoline	Bitumen
	Leaded gasoline	Paraffin waxes
	Kerosene type jet fuel	Petroleum coke
	Other kerosene	Other products

A full description of these primary and secondary oil products and their specifications are given in Annex 2. These specifications are important, because there are different oil product names in use for certain products in the world, for example “stove-oil” and “mazout”; their specifications should be obtained from suppliers so that the oils can be reported using the product names in the *Oil Questionnaire*.

Essential

Petroleum is a complex mixture of liquid hydrocarbons occurring naturally in underground reservoirs.

2 What Units are Used to Express Oil?

General information

Liquid fuels can be measured by their **mass** or **volume**. Within each of these measurements, several units are used in the oil industry:

- The most widely used unit of **mass** (weight) to measure oil is the metric ton (or tonne). For instance, tankers in the oil industry are often described on the basis of their capacity in tonnes, where an ultra large crude carrier (ULCC) is defined as being able to carry over 320 000 tonnes.
- The original unit for most liquid and gaseous fuels is **volume**. Liquids can be measured by the litre, the barrel, or the cubic metre. A common example of the use of volume as the unit of measurement is in the price of oil, quoted in dollars per barrel.

As liquid fuels can be measured by their mass or their volume, it is essential to be able to convert one into the other. In order to make this conversion, the **specific gravity** or **density** of the liquid is needed.

Because crude oil contains a wide range of hydrocarbons from the lightest to the heaviest, the characteristics, including the density, of individual crude oils vary greatly. Similarly, the density of the different petroleum products varies substantially between the products.

The density can be used to classify petroleum products from light to heavy, where for example LPG is considered light at 520 kg/m³ while fuel oil is a heavy product at over 900 kg/m³.

Please note: many countries and organisations use the **tonne of oil equivalent** (toe) when publishing energy balances. The **toe** unit which is based on calorific properties is used to compare oil with other energy forms and should not be confused with the mass measurement in tonnes.

Specific information related to the joint questionnaire

The units employed in the questionnaire are thousand metric tons. When other units of mass are used, data are to be converted to metric tons using conversion factors as found in Annex 3.

For volume to mass conversion, specific densities (see Section 3) should be used for both crude oil and petroleum products, including gases (for example refinery gas); however, in cases where these are not available, please use the average factor shown in Annex 3. Figures should be whole numbers without decimal places.

Essential

Oil data are reported in thousand metric tons in the questionnaire. Figures should be whole numbers without decimal places.

3 How to Make the Conversion from Volume to Mass?

General information

The oil industry in different parts of the world uses different units of measurement. For example, in Europe the metric ton is commonly accepted as the unit of measurement, while in the United States, the volume unit barrel is the unit of choice. In Japan, volume is also used for measuring oil supply and demand; however, the standard unit is the cubic metre.

As so many different units, both volume and mass, are used in the world, it is essential to be able to convert them into a common unit for purposes of comparison. The oil industry internationally uses mainly **barrels (bbl)** as its reference unit. For certain flows such as production and demand, it is **barrels per day (b/d)** which is commonly used.

As mentioned above, to convert from mass into volume or vice versa, the specific gravity or density of the oil must be known. Without going into too much technical detail, a few terms need to be explained in order to understand oil conversion factors.

Density is defined as mass per unit volume, *i.e.* tonne/barrel. The **specific gravity** is the relative weight per unit volume (or density) of a given substance compared to that of water. The density of water is 1g/cm^3 . Motor gasoline, for example, has a lower density as it is much lighter for the same volume. The specific gravity of motor gasoline is therefore smaller than 1. Since volume changes with changes in temperature, data on specific gravity are reported with a reference to a specific temperature (for petroleum, the reference is usually 15 degrees Celsius). Moreover, specific gravity is often quoted as a percentage, *e.g.* a specific gravity of 0.89 is shown as 89.

The term **API gravity** (a standard adopted by the American Petroleum Institute) is commonly used to express the specific gravity of petroleum.

Nota bene: API gravity is defined as: $(141.5 / 60^\circ \text{ specific gravity at } 60^\circ \text{ F}) - 131.5$.

The result is an arbitrary scale for measuring gravity, expressed in degrees API, where the lighter a compound is, the higher its degree of API gravity. For example, what are considered light crudes are generally greater than 38 degrees API, while those with less than 22 degrees API are labelled as heavy crude oils.

Specific gravity and API gravity move in opposite directions. API gravity moves in the same direction as energy content per tonne, *i.e.* the higher the API gravity, the higher the energy content per tonne, whereas specific gravity moves in the same direction as energy content per unit volume.

Specific information

The *Oil Questionnaire* requires oil data to be reported in metric tons. It is therefore often necessary for national statisticians to convert volumetric data into metric tons.

National statisticians should, to the extent possible, obtain information from the reporting enterprises on how quantities of crude oil and petroleum products have to be converted from volume to metric tons. This is particularly important for some

of the oil products in gaseous form (e.g. refinery gas, ethane, LPG) which have to be expressed in mass terms.

Density and gross calorific values of selected petroleum products can be found in Annex 3.

The following table offers an example of converting volume (in this case given in barrels per day) to mass (in metric tons) for two different months (January and February).

Table 4.2 ● Conversion from Volume to Mass – An Example

Imports	Reported data in barrels per day (volume)	Number of days/month	Density mass/volume (average)	Volume/mass tonne/barrel conversion factor	Converted data in metric tons (mass)
Crude oil	1020	31	0.13569	1/0.13569=7.37	$(1020 \times 31) / 7.37 = 4290$
Motor gasoline	546	28	0.11806	1/0.11806=8.47	$(546 \times 28) / 8.47 = 1805$

Essential

In the questionnaire please convert liquid fuels from volume to mass by using appropriate conversion factors based on actual density.

4 Oil Flows

General information

The flow of oil from production to final consumption is complex owing to the variety of elements in the chain. The diagram below provides a simplified view of this flow, covering supply of inputs to the refinery, supply of finished products to the end-user, and the petrochemical flows which interact in the process. These main links in the supply chain will be further discussed below.

Figure 4.1 ● Simplified Flow Chart for Oil

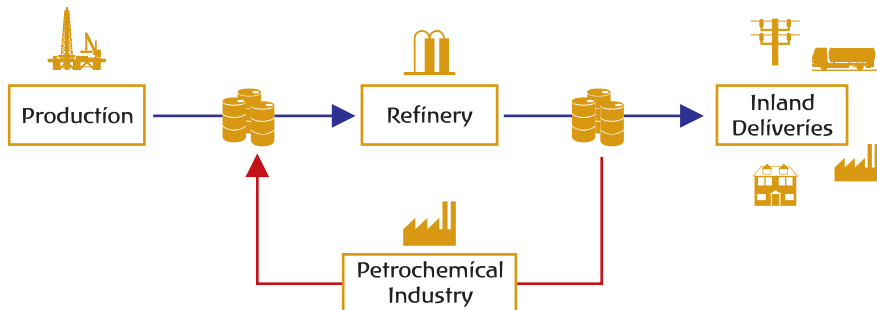

Production of primary and secondary products, trade, stocks, energy sector, transformation, and final consumption are the main elements to be known in order to have a comprehensive view of the flow of oil in a country.

Specific information related to the joint questionnaire

The *Oil Questionnaire* consists of six tables. The nature of each table is as follows:

- Table 1: Supply of Crude Oil, NGL, Refinery Feedstock, Additives and Other Hydrocarbons
- Table 2A: Supply of Finished Products
- Table 2B: Deliveries to the Petrochemical Sector
- Table 3: Gross Deliveries by Sector
- Table 4: Imports by (country of) Origin
- Table 5: Exports by (country of) Destination
- Table 6: Inputs to Autoproducer Electricity and Heat Generation

It is essential that the figures reported in each table are correctly totalled and that the totals in the different tables are consistent with each other where a logical relationship exists. These table relationships are illustrated in the following diagram:

Figure 4.2 ● *Table Relations within the Oil Questionnaire*

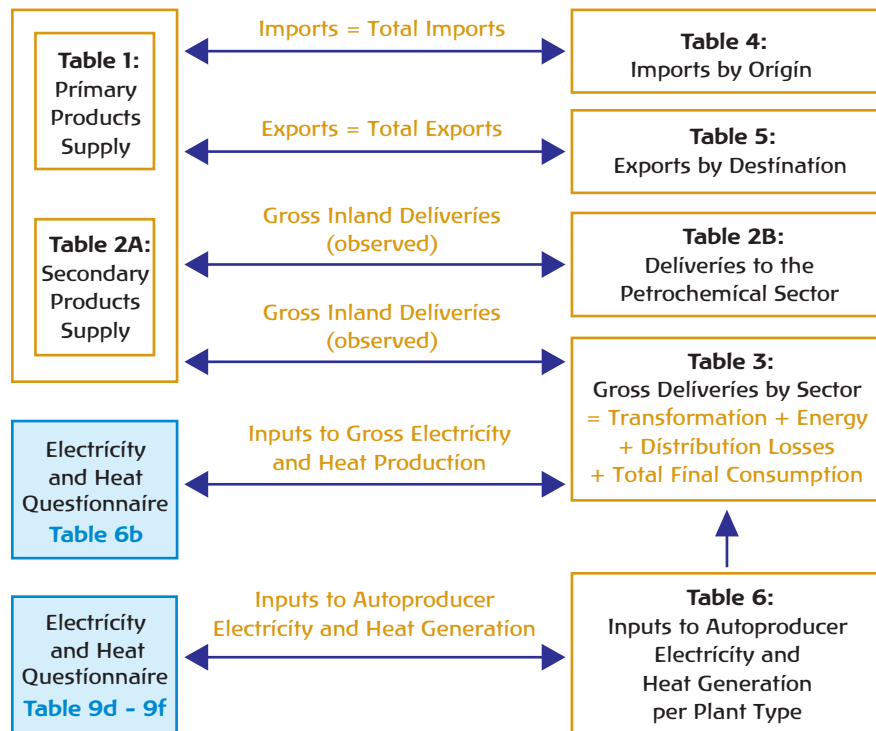

The following totals have to be consistent between the various tables:

- *Products Transferred* as Refinery Feedstocks in Table 1 should correspond to total *Products Transferred* in Table 2A. The total of *Direct Use* in Table 1 should correspond to the total of *Primary Product Receipts* in Table 2A.
- *Imports by Origin* in Table 4 should be summed, and the sum should be reported under *Total Imports* in Table 1 and Table 2A.
- *Exports by Destination* in Table 5 should be summed, and the sum should be reported under *Total Exports* in Table 1 and Table 2A.
- Total *Gross Inland Deliveries* in Table 2B should correspond to *Gross Inland Deliveries (observed)* in Table 2A. *Backflows from Petrochemical Sector to Refineries* in Table 2B should correspond to *Backflows from Petrochemical Industry* in Table 1.
- *Gross Inland Deliveries* in Table 3 should correspond to *Gross Inland Deliveries (observed)* in Table 2A.

All of the oil entering the refinery should be balanced by total gross production of manufactured products plus any declared losses. So the following check applies:

$$\text{Refinery Intake Observed (Table 1)} = \text{Gross Refinery Output (Table 2A)} \\ + \text{Refinery Losses (Table 1)}.$$

In addition, within the oil processes and activities, there are reclassifications of oil products in which the name of the product changes. For example, a quantity of oil imported as “gas oil” may be used as a “feedstock” and reported under each of the names in different tables of the questionnaire.

The corresponding checks on the consistency of the amounts reported are described below. Specific issues affecting reporting and definitions of flows are also described.

Essential

Please remember the interrelationships between the tables in the questionnaire. Key totals should be consistent

5 Oil Supply

The oil supply chain is fairly complex, as several types of feedstock are inputs to refineries, and the resulting output is a wide variety of products with many uses. Moreover, the petrochemical industry is a specific case where oil products are used as feedstocks and oil by-products are returned for further processing. The following paragraphs will first describe these three portions of the supply chain, namely: **supply of crude oil, supply of finished products, and flows of the petrochemical industry**. Information on **trade** and **stocks** common to the supply of crude oil and finished products follows the explanations of the petrochemical industry.

Supply of crude oil, NGL, refinery feedstocks, additives and other hydrocarbons

General information

A flow chart of the various feedstocks from production to refinery input is shown in the diagram below. This flow chart is voluntarily simplified in order to give an overall view of the supply chain for crude oil, NGL, refinery feedstocks and other inputs.

Figure 4.3 • Supply of Crude Oil, NGL, Refinery Feedstocks, Additives and Other Hydrocarbons

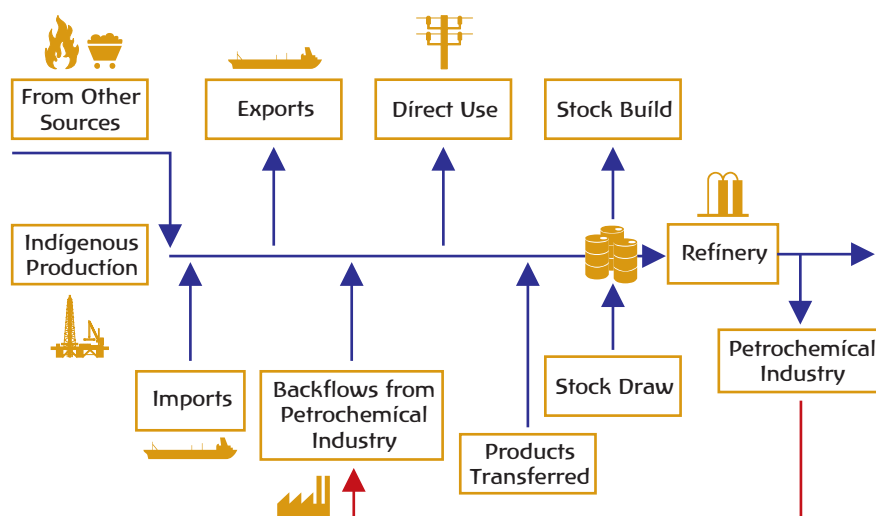

A number of the flows illustrated above require further explanation:

Indigenous Production: Before describing the production process of crude oil, it is necessary to mention that oil production has two meanings, depending on whether referring to primary or secondary products. For primary products, **Indigenous Production** of crude oil, natural gas liquids and condensates refers to the process of extracting these oils from the earth. In the case of secondary products, **Refinery Output** refers to the production of finished products at a refinery or blending plant (see section below on *Supply of finished products*).

Crude oil can be produced from different locations, onshore or offshore fields or from different types of wells, in association with natural gas or not. Any gas extracted from associated oil wells may be flared, vented, reinjected or form part of natural gas production (see Chapter 3 on *Natural Gas*).

When crude oil is produced from the well, it is a mixture of oil, water, sediment and dissolved gases (methane, ethane, propane, butane and pentanes). In the first instance, all gases are separated from the oil/water mixture. The gases are extracted because of their higher value and readily marketable state, such as propane and butane which are liquefied petroleum gases (LPG). In a later stage, the sediment and other unwanted substances are removed in treatment plants.

Figure 4.4 • Simplified Flow Chart for Indigenous Production

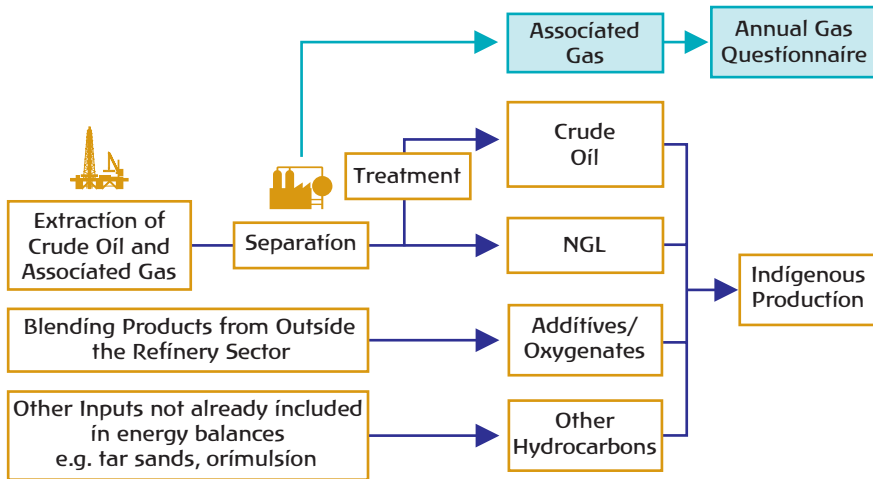

The gases are separated in a wellhead separation plant from onshore wells; from offshore wells, this happens through a separator on the platform. The methane will form the constituent of natural gas, while the other constituents form the **natural gas liquids** (NGL). Natural gas liquids, however, can also be produced in conjunction with natural gas.

Crude oil is very diverse; its characteristics can vary widely. Economically, the most important characteristics are its specific gravity and the sulphur content, as these will be instrumental in determining the price of the crude oil.

To complete the supply balance, other inputs such as additives, oxygenates and other hydrocarbons also need to be included in the production data. Additives and oxygenates are those substances (usually non-hydrocarbon compounds) which are added to fuels to improve their properties, e.g. oxygenates increase the amount of oxygen in motor gasoline.

In the Other Hydrocarbons category are included the production of products such as emulsified oils (e.g. orimulsion) and synthetic crude oil from tar sands. This product category also covers shale oil, liquids produced from the coal liquefaction process, hydrogen and other such products.

Refinery Intake is the total amount of oil (including additives, oxygenates and other hydrocarbons) to have entered the refinery process. *Refinery throughput* refers to this intake and the corresponding output of refined products, described below as refinery gross output in the section *Supply of finished products*. The difference between this intake and output is the losses that occur in the refining process, such as evaporation during distillation.

Specific information related to the joint questionnaire

Indigenous Production in Table 1 of the questionnaire should include only marketable production of crude oil, NGL, and other hydrocarbons.

There are a number of other categories contributing to production in the supply of products to the refinery which are outlined below. For explanations on *trade and stock levels and changes*, please consult the appropriate sections which follow.

From *Other Sources*: These are oils whose production has been covered in other fuel balances. For example, the conversion of natural gas into methanol to be used as a gasoline component, the production of oil from liquefaction of coal or shale oil production from oil shale. Inputs of these oils should be reported as from *Other Sources* if the production of the primary energy form is already covered in other fuel balances, e.g. synthetic oil from coal liquefaction: the production of coal is covered in the *Coal Questionnaire*, the inputs into the coal liquefaction plant are in the Transformation Sector of the *Coal Questionnaire* (Table 1), while the synthetic oil resulting from this process is reported as from *Other Sources of Other Hydrocarbons* in the *Oil Questionnaire*.

Backflows from Petrochemical Industry are oils returned to the refinery from processes in the petrochemical industry. They are by-products of processing feedstock oil supplied to the petrochemical enterprises by the refinery. The refinery may use the backflows as fuel or include them in finished products. Total *Backflows from Petrochemical Industry* reported in Table 1 should be identical to backflows reported in Table 2B.

Products Transferred are oils which are reclassified under another name. There is a corresponding row in Table 2A in which the amounts to be transferred are reported. The need for reclassification arises when semi-finished products are imported for use as feedstock in the refinery and therefore appear in the import data shown in Table 2A. The amounts to be used as feedstock are shown as negative quantities in the *Products Transferred* row in Table 2A and the total of all products transferred is then reported as a positive quantity in the *Refinery Feedstocks* column of Table 1.

Refinery Losses are mass differences which appear between the total oil throughput of the refinery (reported as *Refinery Intake Observed* in Table 1) and the total gross production of finished products (reported in Table 2A). The losses arise through genuine oil losses and the conversion of refinery statistics used within the refineries to mass units.

Direct Use is amounts which do not enter the refinery but enter consumption directly. The “direct use” of crude oil and/or NGL outside refineries must also be reported in Table 2A so that their subsequent disposal can be accounted for. In this case, any figures entered under *Direct Use* for crude oil and NGL should be equal to those shown in Table 2A, *Primary Product Receipts*.

The formula for *Refinery Intake (Calculated)* is the sum of production, inputs from other sources, backflows, transfers (as individually mentioned above), and amounts of imports and stock change, after deducting exports and direct use.

Essential

Indigenous production concerns marketable production within national boundaries, including offshore production.

Refinery intake is the total amount of oil to have entered the refinery process.

Supply of finished products.....

General information

A simplified flow chart of the supply chain from the refinery to the end-user is shown below.

Figure 4.5 • Supply of Finished Products

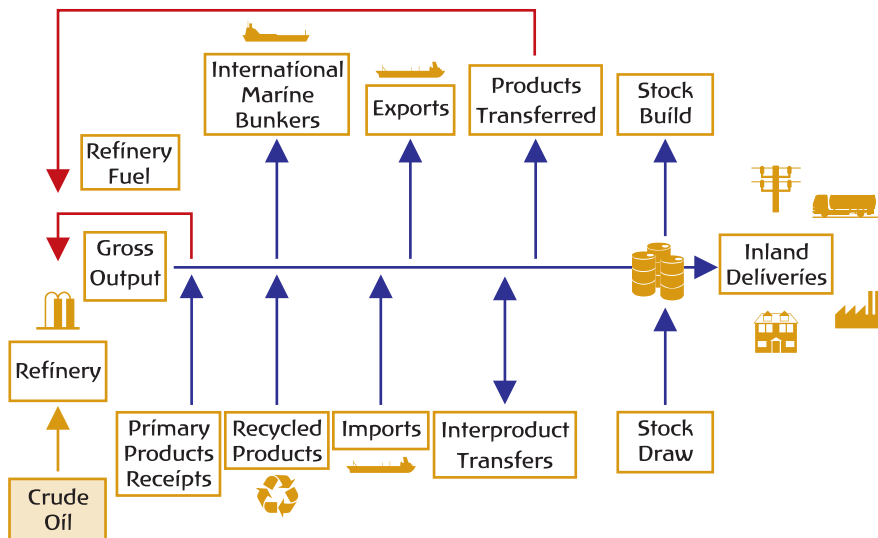

Crude oil as it comes out of the ground is a raw material with limited use. Although it can be used as a burning fuel, the real potential of crude oil is reached when it is refined into a range of products, which will be useful for specific purposes to the final consumer (e.g. gasoline for transportation). The objective of refining is to add value to the raw material, as the total of the refined products should be more valuable than the feedstock.

There are many refinery processes used to transform crude oil. The first basic phase, however, in the refinery process is distillation. Crude oil is heated and fed into a fractionating column at atmospheric pressure, resulting in a separation of the crude oil into 4-6 broad cuts. Beyond the atmospheric distillation unit are more complex units, in which each stream is redistilled to provide a better yield and more precise cut of the final products. For more detailed information, please consult Annex 1, Section 2.

Specific information related to the joint questionnaire

Refinery Output is reported in Table 2A. There are a number of other categories contributing to production in the supply of finished products. These are outlined below.

Primary Products Receipts is the row which brings into Table 2A the crude oil and NGL reported as *Direct Use* on Table 1 so that the disposal can be shown. NGL

should be shown in the NGL column only if it is disposed of as NGL. NGL may be separated into ethane and LPG before disposal. If so, the gases are reported as primary product receipts in the corresponding columns and their disposals will be combined with the disposals of the gases produced in the refineries.

Gross Refinery Output of products must include any fuel use of the products within the refinery (see *Refinery Fuel*, below). If separate figures for refinery fuel and only net refinery production are given, then the refinery fuel must be added to the net production to obtain the gross production figure. The more common problem, however, is that production figures are given but no refinery fuel figures are available. In this case, it is most likely that the production figures are net. The statistician should then check whether all usual petroleum products are reported and, if not, ask whether the missing products are fuels used by the refinery in support of its operations and seek estimates of the amounts concerned. An estimate of the magnitude of missing products and/or refinery fuel may be made by comparing *Refinery Intake Observed* on Table 1 with total production as reported.

Recycled Products are products which are returned after use to recycling plants for cleaning and reprocessing. They are added to the appropriate column in row 3. There are few products in this category. The most notable product is used lubricating oil which is cleaned for reuse.

Refinery Fuel is the fuel used to support refinery operations and does not include use for transport of products to consumers. Use of fuels for the production of electricity and heat for sale should be included in the refinery fuel figures but also separately reported in the bottom rows of Table 2A and in the tables making up Table 6.

Interproduct Transfers cover movements between products which represent reclassification of products owing to changes in quality and therefore specification. For example, aviation turbine fuel which has deteriorated or has been spoiled may be reclassified as heating kerosene. The quantity transferred is shown as a negative quantity in the product column which surrenders the oil, and positive in the product column which receives the oil. It follows that the sum across all products in this row should be zero.

International Marine Bunkers are deliveries of oils to ships for consumption during international voyages (bunker oils) and represent a special case of flows of oil from the country. The oils are used as fuel by the ship and are not part of the cargo. All ships, irrespective of the country of registration, should be included but the ships must be undertaking international voyages, that is, their first port of call must be in a foreign country. International marine bunkers statistics should include fuel delivered to naval vessels undertaking international voyages. Care should be taken to ensure that data representing oil delivered for international marine bunkers meet the definition given here and, in particular, exclude bunker oil used by fishing vessels.

Essential

Refinery output should be reported as gross, including any fuels used by the refinery in support of its operations.

Petrochemical flows

General information

While petroleum products main uses are for their energetic properties, there are a number of non-energy uses of petroleum, most notably in the petrochemical industry. Petrochemicals are chemicals derived from petroleum, and used as the basic chemical building blocks for a variety of commercial products. Dating back to the early 1920s, the petrochemical industry today is very diverse, supplying the raw materials for the manufacturing of plastics, synthetic fibres and rubbers, fertilisers, pesticides, detergents and solvents. Industries as diverse as textile, food, pharmaceutical, automobile, and paint manufacturing use petrochemicals. Petrochemical feedstocks are created from a number of petroleum products, mainly naphtha, LPG and ethane.

The petrochemical industry, however, is not only a large consumer of petroleum products, it is also a producer of petroleum products, as it extracts the necessary components for production of petrochemicals and then returns the by-products to the refineries or to the market.

The flow chart below illustrates the flow scheme between refineries and petrochemical plants.

Figure 4.6 • Deliveries to the Petrochemical Sector

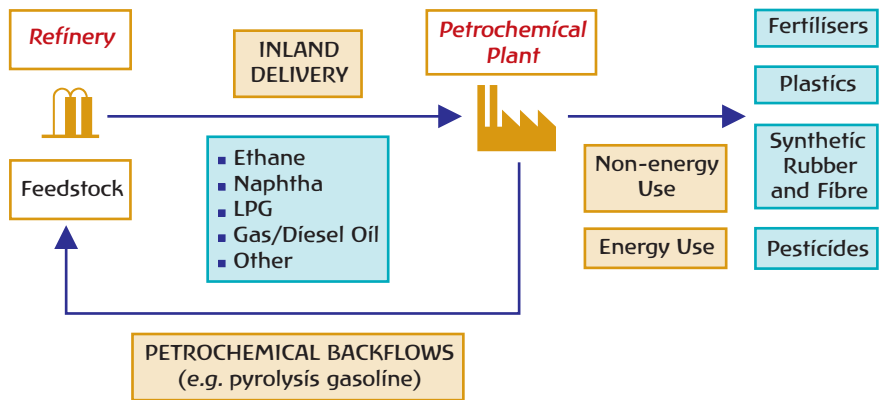

Specific information related to the joint questionnaire

Petrochemical flows are reported in Table 2B. The details of these flows are outlined below.

Gross Deliveries should represent the total quantity of each oil product delivered to the petrochemical companies for feedstock use. It should not be a “net” flow, that is, any oils returned to the refinery from the petrochemical companies should not be subtracted from the deliveries. The feedstock may also cover some or all of the fuel requirements of the industrial process using the feedstock. However, it should not include oils which are used as general purpose fuels unrelated to the process.

Energy Use in the Petrochemical Sector should be the amount of the delivered feedstock oils used as fuel during their processing. The fuels are some of the by-product gases obtained from the feedstock oils during processing. The fuel use information must come through the petrochemical companies that may be able to provide it through the refineries if there is joint refining and petrochemical processing on the site.

Backflows from Petrochemical Sector are oils returned to the refinery from processes in the petrochemical industry. They are by-products of processing feedstock oil supplied to the petrochemical enterprises by the refinery. The refinery may use the backflows as fuel or include them in finished products.

Essential

Gross deliveries to the petrochemical sector are oil products used as raw material in the manufacture of petrochemicals.

Products returning to the refinery for further processing or blending should be reported as backflows.

Imports and exports

General information

One of the basic economic realities of oil is that it is often found in areas far removed from the consuming markets. Two-thirds of the reserves of crude oil are either in the Middle East or in Russia, while almost 90% of the oil is consumed in other areas.

This is why oil needs to be shipped from producing zones to consuming regions. As oil is a liquid and compact form of energy, transportation is made relatively easy. Oil can be transported in tankers, pipelines, railways and trucks, and a vast transportation network exists between producing and consuming regions.

The information required on origins and destinations of the imported and exported oil is of prime importance. Indeed it is important for a country to know from which export country it is dependent for its oil supplies, as in case of an export supply crisis, it can determine how much is imported from that particular country. Similarly, although slightly less important, it is useful to know what the destinations are of the oil exports, so that in case of disruption it is known which export countries will be affected.

Specific information related to the joint questionnaire

The trade figures are reported in several tables of the questionnaire. The total import and export numbers are reported as totals in the supply balance tables; the disaggregated data by origin and destination are requested in other tables.

The sum of all imports from all origins must equal imports reported for each product in the supply tables. Similarly, the sum of all exports by destination must equal exports reported for each product in the supply tables.

Precise definitions of the geographical scope of national territories of certain countries covered by the annual *Oil Questionnaire* are given in the questionnaire's reporting instructions, under Geographical Definitions.

Amounts are considered as imported or exported when they have crossed the national boundaries of the country, whether customs clearance has taken place or not.

Quantities of crude oil and products imported or exported under processing agreements (i.e. refining on account) should be included. Re-exports of oil imported for processing within bonded areas (or free-trade zones) should be included as an export of product to the final destination.

Any gas liquids (e.g. LPG) extracted during the regasification of imported liquefied natural gas should be included as imports in this questionnaire. Petroleum products imported or exported directly by the petrochemical industry should be included.

Import origins or export destinations not listed individually on the trade tables are to be reported under the appropriate *Other* category (*Other Africa*, *Other Far East*, etc.) as shown in Annex 1 of the annual *Oil Questionnaire*. Where no origin or destination can be reported, the category *Not Elsewhere Specified* should be used.

Statistical differences may arise if imports and exports are available only on a total basis (from customs or refinery surveys) while the geographical breakdown is based on a different source of information. In this case, report the differences in the *Not Elsewhere Specified* category.

Crude oil and NGL should be reported as coming from the country of ultimate origin; refinery feedstocks and finished products should be reported as coming from the country of last consignment. In both cases it is the country where the oil is produced which is the reported origin. For primary oils, i.e. crude oil and NGL, it is the country where it was indigenously produced; for secondary oils, it is the country in which they were refined or processed.

Data are to be reported in thousand metric tons. All values should be rounded to zero decimal places and negative values are not allowed.

Essential

Crude oil and NGL should be reported as coming from the country of ultimate origin.

Refinery feedstocks and finished products should be reported as coming from the country of last consignment.

Stock levels and changes

General information

Oil stocks are a critical element of information in an oil balance. The majority of oil stocks are essential to keep the global supply system operating. Stocks allow for the balance between supply and demand; stocks are drawn to help meet demand

when supply falls short, while a stock build offers an outlet for oil products to flow when supply exceeds demand. Not to include stock data in the oil balance leads to a lack of transparency in the market. The trend in stocks is important for many oil analysts when making an evaluation of the oil market situation.

Stocks are a leading indicator of prices: the level of oil stocks often determines the price, e.g. when oil stocks are low it means that there may be a shortage or a need for replenishing, which indicates that prices might be rising. On the other hand, if the industry is amply supplied with the right oil, there may be a price reduction expected. This is why it is important to have information on the situation of oil stocks in the world.

Information on product stocks can be as important as crude oil stocks. For example, crude oil stocks give an indication of the availability of crude to refineries in each country, and therefore are evidence on how well the refineries might provide the domestic market. On the other hand, information on low gasoline stocks before the driving season, or low heating oil stocks before the winter can be a warning signal to refineries, oil companies and governments that not only prices could rise, but shortages might possibly occur – e.g. heating oil problems experienced in autumn 2000.

Data on oil stocks are of particular importance for strategic decisions made by governments or larger oil companies. Aggregate and timely stock information is needed in order to look at longer-term planning so as to ensure adequate supplies to meet demand. Governments require extensive stock information so that they can react appropriately when oil supply disruptions occur (both nationally and internationally). Oil stocks are a critical element of information in an oil balance.

Primary stocks are held by the various companies supplying the markets: ranging from producers, refiners to importers. They are held in refinery tanks, bulk terminals, pipeline tankage, barges and coastal tankers (if they stay in the same country), tankers in port (if they are to be discharged at port) and in inland ship bunkers. Additionally, stocks held for strategic purposes by governments (e.g. US Strategic Petroleum Reserve) or by stockholding organisations (e.g. EBV in Germany) are included in the primary stock category.

Secondary stocks are stocks in small bulk plants (marketing facilities below a certain capacity, e.g. 50 000 barrels in the United States, which receive their products by rail or truck) and retail establishments.

Tertiary stocks are stocks held by end-consumers; these can be power plants, industrial entities or consumers in the residential/commercial sector.

Specific information related to the joint questionnaire

Please note that when referring to stock data, the terms primary and secondary may be used in a slightly different context than when talking about primary and secondary products as mentioned above in Section 1 *What is Oil?*

The annual *Oil Questionnaire* collects data for primary stocks on national territory. Secondary and tertiary stocks, as well as stocks held in oil pipelines, are not included. Pipeline amounts are not included as the amounts are not available for use, i.e. the pipeline cannot function without its contents which are available only when the pipeline is emptied.

Oil stocks and stock changes are to be reported in the supply balance tables.

Opening Stock level is the amount of primary stocks on national territory measured on the first day of the year being reported (1st January, unless a fiscal year is used). *Closing Stock* is the amount of primary stocks on national territory measured on the last day of the year being reported (31st December, unless a fiscal year is used). The *Stock Change* is calculated as the opening stock level minus the closing stock level. Thus, a stock build is shown as a negative number, and a stock draw as a positive number.

Essential

Stock changes should reflect the difference between opening stock level and closing stock level for primary stocks held on national territory.

6 Oil Consumption

Petroleum products are consumed in many areas. They are easily recognised in the gasoline used to fuel cars and the heating oil used to warm homes. Less obvious are the uses of petroleum-based components of plastics, medicines, food items, and a host of other products.

Oil consumption occurs in the following main sectors:

- In the transformation sector.
- By the energy industries in the energy sector.
- In the transportation and distribution of oil (although limited).

Figure 4.7 ● Oil Consumption by Sector

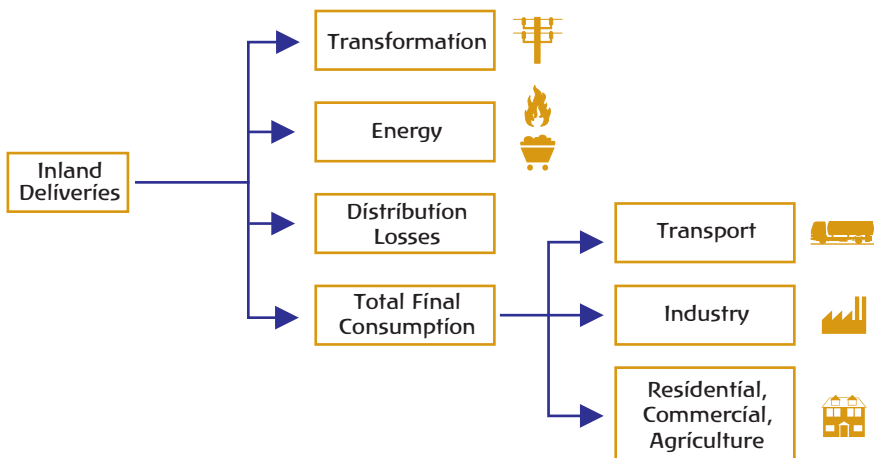

- In the various sectors and branches of final consumption (industry, residential, etc.), including both energy and non-energy uses of oil.

A short description of these sectors is given in the next paragraphs, highlighting the impact of the specificity of the end-use sector on statistics. For general information, refer to Chapter 1, *Fundamentals*, Section 8.

Consumption of oil in the transformation sector

General information

The quantities of oil used in the process of transformation of oil to another energy form should be reported in the **transformation** sector. This largely consists of oil products burnt in order to produce electricity or heat, but covers all instances of oil products being converted into another form of energy. Examples of this include oil products used in coke ovens, blast furnaces, oil used to produce gas in a gasification plant, or as binding materials in producing patent fuels.

The use of oil products in the generation of electricity has been in steady decline since the 1970s. Representing almost 25% in 1973, inputs of oil for electricity generation have declined at a rate of 2.4% per annum since, and currently account for less than 8% of world electricity generation.

Specific information related to the joint questionnaire

Electricity and Heat Generation: Electricity and heat plants are divided according to their main business purpose (public or autoproducer) and the types of energy they produce (electricity, heat, or both).

Total amounts of oils delivered to power plants for electricity generation only should be included in the *Transformation Sector*. Quantities shown as used at stations containing combined heat and power (CHP) units should represent only the fuel used for electricity generation and for generating heat for sale. Fuel reported as delivered to autoproducer heat-only plants should be the amount used to produce heat for sale. The quantities of fuel consumed by the autoproducer plants for the production of heat which is not sold will remain in the figures for the final consumption of fuels by relevant sector of economic activity. Please refer to Chapter 2 on *Electricity and Heat* for further information.

Blast Furnaces: Report only the oils which are injected into the blast furnaces. Use of oils elsewhere on the iron and steel site or for the heating of air for blast furnaces will be reported as final consumption or energy sector use. See notes on blast furnaces in *Annex 1*.

Petrochemical Industry: See above section on *Petrochemical flows*. From the energy statistician's viewpoint, the petrochemical conversion of feedstock input into "backflows" returned to refineries is a fuel conversion process. The inputs to the process should therefore be reported in the transformation sector. The contribution of the different feedstock types to the backflows cannot be known with any certainty

and so a simple model approach is adopted to estimate the transformation input quantities.

To keep the total fuel use figures correct and avoid double counting, the quantities reported in the transformation sector must be subtracted from the final consumption by the chemical and petrochemical industry reported later in the questionnaire.

Essential

In the transformation sector, only report oil and oil products transformed into other forms of energy.

Consumption of oil in the energy sector

General information

Besides being used in the transformation sector as detailed above, oil products can be used by the energy industry to support energy production. This is, for example, oil used in a coal mine in support of the extraction and preparation of coal within the coal-mining industry. This is consumption of oil used for heating, operating a generator, pump or compressor by the **energy** sector to support the extraction or transformation activity.

Specific information related to the joint questionnaire

Report in the *Energy Sector* the quantities of oils consumed within the fuel and energy enterprises in the sense that they disappear from the account rather than appear after transformation as another energy commodity. The commodities are used to support the various activities within the fuel extraction, conversion or energy production plant, but they do not enter into the transformation process.

Note that quantities of oil transformed into another energy form should be reported under the *Transformation Sector*. Care should be taken to distinguish between oils used for heat-raising in the activity and those used for transport. Transport fuels should be reported in the *Transport Sector*. Thus, oil consumed in support of the operation of oil and gas pipelines should be reported in the *Transport Sector*.

In the case of blast furnaces, report only the quantity of oil (if any) used to heat blast air. Oils injected into the blast furnace should be reported as transformation use.

Essential

In the energy sector, only report oil used by the energy industries to support the extraction or transformation activity.

Oil transport and distribution losses.....

General information

The transportation and distribution of petroleum products often involve multiple episodes of handling and storage. There are four main means for transporting petroleum as it moves from the wellhead to the refinery and on to the final consumer: by sea, pipeline, railway and roadway. Storage facilities along the transportation route facilitate the movement of the products. These are often found between the different means of transportation, such as at ports where tankers are offloaded and products continue via pipeline.

In the course of this transportation, there are a number of ways in which some amounts of oil can be lost from the supply stream. The most spectacular example of this is when a tanker spills at sea, such as in 1989 when nearly 250 000 barrels of crude oil were spilt off the coast of Alaska. Pipeline leakage, train car derailments and tanker truck accidents are also possible sources of losses along the transportation and distribution chain.

Specific information related to the joint questionnaire

The category *Distribution Losses* (Table 3) should include all losses which occur during transportation and distribution, including pipeline losses.

If no distribution losses have been reported, check with the reporting entity whether reported losses have not been included with the statistical difference. If independent measures exist to determine the transportation and distribution losses, then these amounts should be reported in the appropriate category and not included with the statistical difference.

Losses are to be reported in thousand tonnes, values reported are positive numbers.

Essential

All quantities of oil products lost during transportation and distribution should be reported in distribution losses.

Final consumption.....

General information

Final consumption is all energy used by final consumers in the **transport, industry, and other sectors** (residential, commerce, public services and agriculture). It excludes all oil used for transformation and/or own use of the energy-producing industries.

While oil's share in world total energy supply has been decreasing over the last 30 years, world oil consumption has nevertheless grown during this period. This growth has come almost entirely from the transport sector's energy demand, as alternatives to oil for use in transportation have proven difficult to develop.

Currently at 57%, transport accounts for the largest portion of total world final consumption of oil. This is an increase on 1973 levels, where the transport sector consumed over 42% of the world total. Industry and “other sectors” have both fallen from their 1973 level of just over 26% and 25% respectively, to roughly 20% and 17% at present.

Data are collected for energy and non-energy (feedstock) use of oil in the sectors and branches of final consumption. The most important use as feedstock is in the chemical and petrochemical industry.

Specific information related to the joint questionnaire

Transport Sector

The figures reported here should relate to use in the transport activity itself and not to consumption by the transport company for non-transport purposes. Similarly fuels consumed for transportation in industries or other sectors should be considered consumption in the transport sector and not for the industrial or other sector activity.

Aviation: Figures for quantities of aviation fuels delivered to aircraft should be divided between domestic and international flights. Domestic flight fuel use should include quantities used for military aircraft. International flights are defined in a manner similar to the definition of international sea voyages. Any flight for which the next landing is in a foreign airport is an international flight. All other flights are domestic.

Road Transport: Report quantities used by any type of vehicle for transportation on public roads. Off-road use should be excluded.

Rail: Include all oils used for diesel-propelled locomotives for freight, passenger traffic and movements of locomotives for rolling stock management.

Inland Waterways (national navigation): Report oil consumption in vessels used in inland waterways and for coastal shipping. Oil fuels used in vessels undertaking international voyages must be reported as *International Marine Bunkers*. Oils consumed by fishing vessels must be reported under *Agriculture, Forestry and Fishing*.

Industry Sector

The definitions of the industrial branches shown in the questionnaire in terms of the economic activities they contain are given by reference to ISIC rev. 3 and NACE rev. 1. The definitions are given in the notes accompanying each of the annual questionnaires. The industry sector includes the construction branch but not the energy industries.

The figures reported in the *Industry Sector* for the consumption of fuels by enterprises should exclude quantities used to generate electricity and heat for sale and for transport on public roads (see the above section on *Consumption of oil in the transformation sector* and the paragraphs above on *Transport Sector*).

Quantities should include fuels used for all non-energy purposes but the non-energy quantities must also be reported in Table 3 so that they are identified separately.

Other Sectors

The branches of *Other Sectors* (Commerce and Public Services, Residential and Agriculture) are common to the annual questionnaires, and are detailed in Section 8 of Chapter 1: *Fundamentals - Final Energy Consumption*.

Non-energy Use

A number of fuels may be used for non-energy purposes, as raw materials in the different sectors. These are products which are neither consumed as a fuel nor transformed into another fuel. For further information, please refer to Section 8 of Chapter 1, *Fundamentals - Non-energy Uses of Fuels*.

Essential

Final consumption is all energy delivered to final consumers and does not include transformation or uses in the energy-producing industries.

7 Additional requirements for the Joint Questionnaire on Oil

Inputs to autoproduction

General information

With the growing importance of the environmental debate, it has become essential to identify total consumption of fuels in each respective industry and consuming sector, so that for each sector appropriate measures can be developed to conserve energy and reduce greenhouse gas emissions.

For general information and definitions for autoproduction, please refer to Chapter 2, *Electricity & Heat*, Section 1.

Specific information related to the joint questionnaire

Inputs to autoproducer electricity and heat production are reported on Table 6.

This table provides information on the fuel use by autoproducers of electricity and heat for sale according to their principal economic activity. The table is separated into three parts corresponding to three recognised types of generating plant: *Electricity-only*, *CHP*, and *Heat-only*. The data are used for tracking fuel inputs and electricity and heat outputs by autoproducers as part of the United Nations efforts to understand CO₂ emissions.

In the case of CHP plants, reporting separate figures for the amounts of fuel used for the production of electricity and heat requires a method of dividing the total fuel use between the two energy outputs. The division is required even if no heat

is sold because the fuel use for electricity production must be reported in the *Transformation Sector*. The method proposed is described in *Annex 1*, Section 1 of the *Manual* and should be followed carefully.

Please note that the totals reported in this table should equal the respective totals reported in the *Transformation Sector* (Table 3). Also note that a similar table is included with the *Electricity and Heat Questionnaire*. To avoid inconsistent reporting, please contact the person responsible for the completion of the electricity questionnaire in your country.

Essential

Report oil used by autoproducers as input for electricity and heat (sold) production in the respective sectors.

Solid Fossil Fuels & Manufactured Gases



1 What Are Solid Fossil Fuels and Manufactured Gases ?

General information

Solid fuels and manufactured gases cover various types of coals and products derived from coals. By convention, most of the organisations dealing with energy statistics prefer to include solid renewables fuels such as fuelwood and charcoal in the reporting and processing of renewables energy. As a consequence, solid renewables fuels will not be included in this chapter but in Chapter 6 on *Renewables and Waste*.

Primary coal is a fossil fuel, usually with the physical appearance of a black or brown rock, consisting of carbonised vegetal matter. The higher the carbon content of a coal, the higher its rank or quality. Coal types are distinguished by their physical and chemical characteristics. These characteristics determine the coal's price and suitability for various uses. All primary coal products covered in this chapter are solid fuels. The chapter also includes peat which is another primary fuel closely related to coal.

Derived fuels include both solid fuels and gases produced during coal processing and by coal transformation. More detailed information on derived coal products and the equipment used for their production is available in *Annex 1 – Fuel Conversion and Energy Production Processes*.

There are three main categories of coal: hard coal, sub-bituminous coal and brown coal (also called lignite). Hard coal refers to coal of **gross calorific value** (GCV) greater than 23 865 kJ/kg; it includes two sub-categories: coking coal (used in blast furnaces), and other bituminous coal and anthracite used for space heating and raising steam (so the name of steam coal for this sub-category). Lignite or brown coal refers to non-agglomerating coal with a GCV less than 17 435 kJ/kg. Sub-bituminous coal includes non-agglomerating coal with a GCV comprised between those of the other two categories.

The secondary or derived products include patent fuels, briquettes (BKB and peat briquettes), gas and coke-oven cokes, gas-works gas and coke-oven gas, blast-furnace gas and basic oxygen steel-furnace gas.

Over the last 30 years, the share of coal in global total primary energy supply (TPES) has been stable at around 25%, leading to a 56% growth compared to the 1973 supply. It is interesting to note that the consumption of coal dramatically increased for electricity production by over 250% but that, on the other hand, the consumption of the residential sector decreased by 65%. In other words, coal is now mainly used for electricity production and to a lesser extent by industry.

Specific information related to the joint questionnaire

The *Solid Fossil Fuels and Manufactured Gases Questionnaire* is often referred to as the *Coal Questionnaire*, because it covers various types of coals and products derived from coals.

The questionnaire covers fossil fuels and manufactured gases which are divided into primary and derived products. They further occur in the two separate physical categories as illustrated by the following table.

Table 5.1 ● *Primary and Derived Coal Products*

PRIMARY COAL PRODUCTS	Coking coal	SOLID FOSSIL FUELS	
	Other bituminous coal and anthracite		
	Sub-bituminous coal		
	Lignite/brown coal		
	Peat		
DERIVED FUELS	Patent fuels		MANUFACTURED GASES
	Coke-oven coke		
	Gas coke		
	Briquettes		
	Gas-works gas		
	Coke-oven gas		
	Blast-furnace gas		
Oxygen steel-furnace gas			

For detailed definitions and fuel characteristics, please refer to the product definitions in *Annex 2*.

It should be noted that the *Coal Questionnaire* covers coals produced from operating surface and underground coal mines, as well as coal recovered from mine waste piles, preparation plant slurry ponds and other waste accumulations. It also covers peat produced from peat cutting or harvesting operations.

Because coal is classified in many different ways, there is often confusion in the classification of primary coals, particularly as regards lignite/brown coal and sub-bituminous coal. In terms of energy content, sub-bituminous coal is a category that overlaps the boundary between hard coal and brown coal. Non-agglomerating highly volatile coals which fall in an energy content range between 17 435 kJ/kg (4 165 kcal/kg) and 23 865 kJ/kg (5 700 kcal/kg) should be reported as sub-bituminous coals even if that classification differs from the standard applied at the national level. Sub-bituminous coals are further assigned to the categories "hard coal" and "lignite/brown coal" by the international agencies collecting the statistics. Generally, sub-bituminous coals with energy content above 18 600 kJ/kg (4 440 kcal/kg) are considered hard coals, while those below are considered lignite/brown coals.

Although the *Coal Questionnaire* refers to “solid” fuels, it should be noted that statistics on only solid fossil fuels are reported on the questionnaire. Fuelwoods, and biodegradable and non-biodegradable solid fuels and wastes like tyre-derived fuel, plastics, wood wastes, charcoal and biomass energy crops should be reported on the *Renewables and Waste Questionnaire*. It is essential that renewable and waste products co-fired with coal and coal products be reported separately on the *Renewables and Waste Questionnaire*. The statistician should be aware that, in the transformation sector, both the input energy and the output energy derived from the renewable/waste fraction of the energy are to be accounted for.

The *Coal Questionnaire* covers coals and coal products processed in patent fuel and BKB plants, coke ovens, blast furnaces, gas works and oxygen steel furnaces. All of the inputs and production in each product chain are to be reported on the *Coal Questionnaire* and other related questionnaires. For example, coking coal inputs to coke ovens relate directly to the production of coke-oven coke and coke-oven gas on the *Coal Questionnaire*. Other bituminous coal and anthracite, lignite/brown coal and peat inputs to patent fuel and BKB plants must be reported further as production and consumption of the derived fuels “patent fuel” and “BKB” on the *Coal Questionnaire*. These relationships apply to all of the secondary products derived from primary energy inputs.

Essential

The Solid Fossil Fuels and Manufactured Gases Questionnaire includes not only primary coals, but also derived solid fuels and manufactured gases.

Solid fossil fuels do not include solid biomass and waste (fuelwood, charcoal and plastic) which should be reported in the Renewables and Waste Questionnaire.

When reporting derived solid fuels and manufactured gases, it is important to report production and consumption in the derived product chain when inputs to the process are reported in the primary product chain.

2

What Units are Used to Express Solid Fuels and Manufactured Gases?

General information

Solid fuels are usually measured by mass (tonnes, thousand tonnes, etc.). Quantities reported should be on an “as received” basis – i.e. using the moisture and ash content of the product at the point of receipt.

In some technical reports, coal data can also be found in terms of **tonnes of coal equivalent** (tce). The tonne of coal equivalent is not a unit of mass but a unit of energy that is more widely used in the international coal industry to make comparisons between various fuels. A tonne of coal equivalent is defined as 7 million kilocalories. The relation between tonne of oil equivalent (toe) and tonne of coal equivalent is: 1 tce = 0.7 toe.

Manufactured gases can be measured in several units: either according to energy content (also referred to as heat) or volume.

Within each of these measurements, several units are used in the natural gas industry:

- In order to measure **energy**, it is possible to use joules, calories, kWh, Btu, or therms.
- In order to measure **volume**, the most frequently used unit is the cubic metre or cubic foot.

Specific information related to the joint questionnaire

The units employed in the questionnaire for solid fossil fuels are thousand metric tons. When other units of mass are used, data are to be converted to metric tons using conversion factors as found in Annex 3.

The quantities of gases must be expressed in terms of their energy (heat) content and reported in terajoules (TJ). The energy content may be calculated from the volume measurement by the enterprise providing the data or by the statistician using the gross calorific value of the gas. The use of the gross calorific value is particularly important for gas-works and coke-oven gases where there is a difference between gross and net calorific values. There is very little difference between gross and net calorific values for blast-furnace and oxygen steel-furnace gases, so gross calorific value may be used if it is available, but net calorific value can be used if the former is not available.

For information, the net heat content of the gases can be derived from the gross heat content by using the following factor:

Table 5.2 • Difference between Gross and Net Calorific Values

Gas	Gross to Net Ratio
Gas-works gas	0.9
Coke-oven gas	0.9
Blast-furnace gas	1.0
Oxygen steel-furnace gas	1.0

Essential

Solid fuels data are reported in thousand metric tons.

The quantities of gases are expressed in terms of their gross energy (heat) content and reported in terajoules (TJ).

3 How to Make the Conversion from Mass and Volume to Energy?

General information

Since the calorific values for the respective solid fossil fuels can dramatically vary from product to product (for instance, over 23 865 kJ/kg for hard coal, and less than 17 435 kJ/kg for brown coal), it is essential to complement the submission of the various solid fuels in units of mass by their respective calorific values. The calorific values are critical because they are used for several purposes: to create the energy balance, to calculate the estimate of CO₂ emissions, and to check thermal efficiencies of inputs and outputs reported in the transformation sector.

The conversion to energy units is usually done using the gross calorific value of the respective products. Each of the products may have a different gross calorific value, and for each product, the different flows (e.g. production, imports, use in public electricity) may have different values. Moreover, calorific values can change over time owing to changes of processes and/or technology. It is important to consult with the reporting entities and other experts on the respective country's manufactured gas products when deriving calorific values.

As regards the manufactured gases, the most common method of metering and accounting for these gases is by volume (e.g. m³). However, it is often the energy content, not the volume, of the gases that is of interest for the user. As a consequence, for energy study, it is more important to express the flows of manufactured gases in energy unit than in volume unit. Chapter 3 on *Natural Gas* describes in more details how to make the conversion from volume to energy related to gas (Section 2).

Specific information related to the joint questionnaire

■ Solid fossil fuels

The *Coal Questionnaire* requires solid fossil fuels data to be reported in metric tons. Equally important, the questionnaire requires both the gross calorific value and the net calorific value for each type of reported solid fuel.

Calorific values have to be reported in units of megajoules per tonne (MJ/t). Ideally, these calorific values are reported by the data provider. As an alternative, they can be derived by the statistician in consultation with the data provider and solid fuel and manufactured gas experts familiar with the respective country's energy portfolio. As a last solution, the statistician may consult *Annex 3 – Units and Conversion Equivalents* and use the ranges for each product to derive calorific values. However, the data provider and other experts on the respective country's solid fossil fuel products should be consulted in deriving the calorific values.

In cases where data are provided to the national administration in energy units, units of mass can be calculated by converting the energy units to units of gigajoules, and then dividing the energy units by the gross calorific value provided in megajoules per tonne. The resulting dividend is the mass, in thousand tonnes, of the respective product “as received” with moisture included.

■ Manufactured gases

To convert manufactured gas from volume units to energy units (terajoules are used on the *Coal Questionnaire*), use the gross calorific value per volume unit for each flow of the product. The gross calorific value per volume unit should be multiplied by the total volume to arrive at the total gross energy content in terajoules (TJ).

Essential

Report both the gross and the net calorific values of the solid fossil fuels.

Report the manufactured gases in gross calorific values, using specific calorific values when available.

4 Coal Flows

General information

A flow chart from production to consumption is shown on Figure 5.1. This flow chart is voluntarily simplified in order to give an overall view of the supply chain.

Production, trade, stocks, energy sector, transformation and final consumption are the main elements to be known in order to have a comprehensive view on the flow of solid fossil fuels and manufactured gases in a country. The details in reporting depend on the use of the information.

Figure 5.1 ● Simplified Flow Chart for Coal

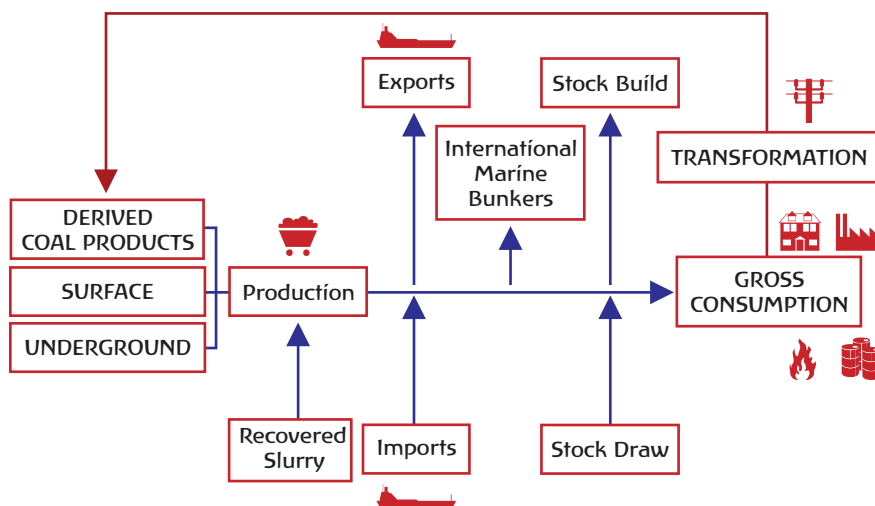

Specific information related to the joint questionnaire

The *Coal Questionnaire* consists of six tables. The nature of each table is as follows:

- Table 1: Supply and Transformation Sector, Energy Sector and Final Consumption, Energy End-use (non-energy, industry, transport and other sectors)
- Table 2: Imports by Source (country of origin)
- Table 3: Exports by Destination
- Table 4: Calorific Values
- Table 5: Production, Stocks, Employment and Productivity of Labour in Coal Mines
- Table 6 Inputs to Autoproducer Electricity and Heat Generation

It is essential that the figures reported in each table are correctly totalled and that the totals in different tables are consistent wherever a logical relationship exists. The relationships between these tables are illustrated in Figure 5.2.

Figure 5.2 ● Table Relations within the Coal Questionnaire

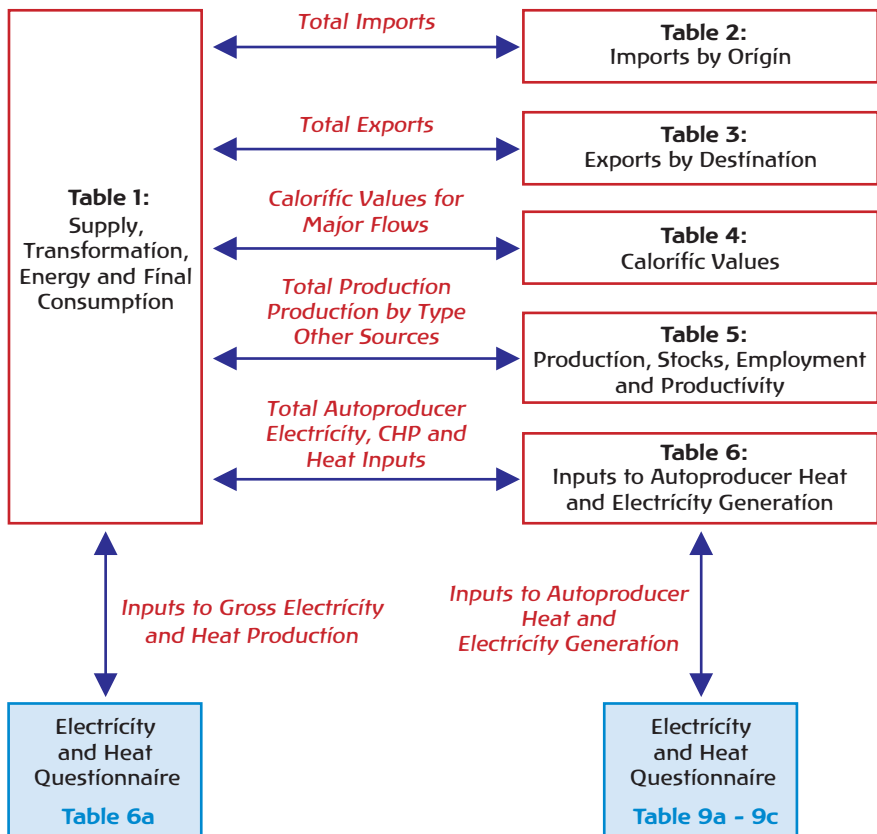

The following totals have to be consistent between the various tables:

- *Imports by Source* in Table 2 should be summed, and the sum must equal the entry for *Total Imports* in Table 1.
- *Exports by Destination* in Table 3 should be summed, and the sum must equal the entry for *Total Exports* in Table 1.
- *Production by type of production* in Table 5 – underground, surface and recovered slurry (other sources) – for each coal category should be summed and the sum must equal the sum of the components of each coal category reported on Table 1.
- *Inputs to Autoproducer Electricity and Heat Generation* in Table 6 must equal the inputs for each category of autoproducer plant (electricity-only, CHP and heat-only) reported in the *Transformation Sector* of Table 1.

Essential

Please remember the internal interrelationships between the tables in the questionnaire. Key totals should be consistent.

5 Coal Supply

As defined in Section 9 of Chapter 1, *Fundamentals*, supply includes production, trade and stock changes. Each of these three components will be detailed in the next paragraphs.

Production

General information

Most primary coal production occurs either in **underground** mines or in **opencast** (surface) **mines**. Some production can also come from **recovery** of coal from waste piles, slurry ponds and other sources created by conventional mining in previous years.

Consequently, primary production of coals is usually divided into three sub-categories: underground (deep-mined), surface (opencast) and recovery. This last sub-category includes recovered slurries, middlings and other low-grade coal products which cannot be classified according to type of coal; it also includes coal recovered from waste piles and tips and which has not been included in production for earlier years.

Peat production must be the quantity for fuel purposes only. Quantities used for other purposes must be excluded.

Production of derived coal products (both solid and gaseous) occurs at various surface facilities, or can result from transfer of a product from another site. Because of this, the distinction between “underground” and “surface” does not apply to derived coal

products. The facilities are often located adjacent to primary coal production sites (patent fuel plants, BKB plants and gas works), or are located adjacent to integrated steel mills which consume coal (coke ovens, blast furnaces, etc.).

The quantities reported are the amounts extracted or produced, after any operation for removal of inert matter. In the coal-mining industry, this is generally referred to as “clean” or “saleable” production. Production includes the quantities consumed by the producer in the production process (e.g. for heating or operation of equipment and auxiliaries) as well as supplies to other producers of energy for transformation or other uses.

Specific information related to the joint questionnaire

Production is to be reported in two places: in Table 1 on Supply and in Table 5 on Production, Stocks, Employment and Productivity of Labour in Coal Mines.

In Table 1, for primary products (except peat) the indigenous production is to be reported separately for underground production and for surface production. No breakdown between surface and underground production should be reported for derived fuels and peat.

Recovered slurry (other sources) refers to recovery slurry production for primary coal products and to production from other sources for derived fuels. If manufactured gases are produced as a main plant activity, they are reported as production; if manufactured gases are produced by mixing gases resulting from other activities, or by cracking of natural gas or oil, they should be reported as production from other sources.

Data are to be reported either in indigenous production, underground production, surface production or recovered slurries (production from other sources) according to fuel type and method of production.

In Table 5 report data aggregated to *Hard Coal* and *Brown Coal* only.

Data have to be reported in thousand tonnes for all solid fossil fuels and in terajoules for all manufactured gases. Values should be rounded to zero decimal places and negative values are not allowed.

Essential

Report the quantities of fuels produced calculated after any operation for removal of inert matter.

Imports and exports

General information

Compared to other fuels such as natural gas, coal is a product that is easily transported over long distances either by boat or by train. As a consequence, trade of coal has always been developed from producing to consuming countries.

Hard coal trade accounts for about 20% of the world hard coal total consumption; the share even amounts to between 35% and 40% of coking coal consumption.

Because of the significant levels of coal trade, it is important for a country not only to know how much coal is imported and exported, but also to know the origins and destinations of the imports and exports. This level of detail should be available for the products that are significantly traded, i.e. coking coal, other bituminous and anthracite, sub-bituminous coal, lignite/brown coal, coke-oven coke and BKB.

For the other coal products (mainly manufactured gases and peat), the amounts of imports and exports are usually extremely limited; therefore, there is no real need to have a breakdown of the origins and destinations of these products.

Specific information related to the joint questionnaire

Total trade is to be reported in Table 1. Imports by origin and exports by destination are to be reported respectively in Table 2 and Table 3

Amounts are considered imported or exported when they have crossed national boundaries of the country, whether customs clearance has taken place or not.

For imports it is important to know (therefore to report) the ultimate origin of the coal (the country in which the coal is produced), while for exports it is essential to show the ultimate destination (the country in which the coal will be consumed) of domestically produced coal. The companies responsible for the commercial arrangements leading to the trade should be able to provide the data.

Imports concern coal that is to be consumed within the country, and exports concern coal that has been domestically produced. Transit trade and re-exports are therefore not to be included in the trade reported.

Where no origin or destination can be reported, or where the country is not specified in the table, the category *Other* may be used. Please specify the country if the information is available.

Data have to be reported in thousand tonnes for all solid fossil fuels and in terajoules for all manufactured gases. All values have to be rounded to zero decimal places and negative values are not allowed.

Essential

Imports should cover coal entering a country for domestic consumption, and reported under the country where coal was produced.

Exports should be domestically produced coal leaving a country, and reported under the country where coal will be consumed.

Transit trade and re-exports are therefore not to be included.

Stock levels and changes

General information

Primary coal products, because of their solid state and relatively inert character, are often held in stock to cover periods when demand is higher than production or, more generally, than supply. To some extent, primary coal production – and consumption in some sectors (heating, for instance) is seasonal in nature, and stocks must be used to balance periods of high and low availability against periods of high and low demand.

While some solid derived coal products (coke-oven coke, patent fuel, BKB) are also held in stock, manufactured gases are seldom in stock.

As in the case of oil, timely, detailed and accurate data on the changes in coal stocks are essential for policy-makers and market analysts.

Specific information related to the joint questionnaire

Coal stock changes are to be reported in Table 1 (*Supply table*).

Report the difference between the opening stock level and closing stock level for stocks held on national territory. Opening stock levels are the stock levels as of the first day of the time period requested; closing stocks are the stock levels at the end of the time period. For example for a calendar year, opening stocks are the stock levels on 1 January, closing stocks are measured on 31 December.

A stock build is shown as a negative number and a stock draw is shown as a positive number.

Data have to be reported in thousand tonnes for all solid fossil fuels and in terajoules for all manufactured gases. All values have to be rounded to zero decimal places and negative values are not allowed.

Essential

Report stock changes for all primary coal products and all derived fuels.

Stock changes are calculated as the opening level minus the closing level.

6 Coal Consumption

The consumption of solid fossil fuels and manufactured gases occurs in several sectors:

- In the transformation sector.
- By the energy industry within the energy sector.

- In the transport and distribution of fuels (although very limited).
- In the various sectors and branches of final consumption (industry, residential, etc.). This includes both energy and non-energy uses of the fuels.

A short description of these three sectors is given in the next paragraphs. For general information, refer to Section 8 of Chapter 1, *Fundamentals*.

Consumption of coal in the transformation sector

General information

There is a wide variety of transformation plants which are used to derive energy products from solid fossil fuels (mainly coal). These energy plants include patent fuel plants, coke ovens, gas-works plants, blast furnaces as well as electricity plants, heat plants and combined heat and power plants (CHP). They also include liquefaction plants to produce synthetic oil.

In 2001, 84% of coal consumed in the world was transformed into one product or another. About 82% of hard coal and 94% of brown coal are used for transformation. The largest use of primary coal products is for the generation of electricity and heat – for which consumption is 67% of hard coal and 92% of brown coal. Another 12% of hard coal is transformed into coke-oven coke. About 80% of coke-oven coke is utilised to charge blast furnaces where it is transformed into coke-oven gas and pig iron.

The traditional use of gases manufactured at integrated steel mills (blast-furnace gas, coke-oven gas, oxygen steel-furnace gas) is to heat the transformation plant, resulting in its assignment to the energy sector. However, 38% of oxygen steel-furnace gas, 33% of blast-furnace gas and 18% of coke-oven gas are used to produce electricity and heat.

Taking into account the large share of coal that is transformed, it is therefore essential to keep track of the quantities of fuels transformed as well as of the derived energy products.

Specific information related to the joint questionnaire

Inputs of solid fossil fuels and manufactured gases into transformation processes are to be reported in the second part of Table 1.

Note the reporting of specifications for blast furnaces and coal.

■ Blast furnaces

Ensure that fuels reported as used in blast furnaces or at blast furnaces to support blast furnace operations are reported separately in the transformation and energy sectors respectively. The description of blast furnace processes in *Annex 1*, Section 3 gives guidance as to which fuels enter the transformation process and which are used to heat the air blast outside the blast furnace.

In the absence of exact information from the iron and steel enterprises, the statistician should assume that all blast-furnace gas and coke-oven gas used at blast furnaces are for blast-air heating and should be considered as energy sector consumption. All cokes, coals or oils should be treated as transformation use in the blast furnace. Occasionally, natural gas use may be reported but the nature of its use is less clear as it can be consumed for either purpose (transformation or energy use). If natural gas reporting occurs, the statistician should consult with the data provider in order to ascertain whether it should be reported in the transformation or the energy sector.

Never report the use of coke in blast furnaces as “non-energy use”.

■ Liquefaction

Liquefaction covers the production of oils from coal, oil shale and tar sands. The process takes place above ground, so the operators of the plant should know the quantities entering the process. Ensure that *in situ* (underground) coal liquefaction and *in situ* extraction of oil from tar sands are excluded. The oil produced from *in situ* processes is reported as indigenous production under *Other Hydrocarbons* in the *Oil Questionnaire*.

Figure 5.3 ● Coal Transformation Schematics

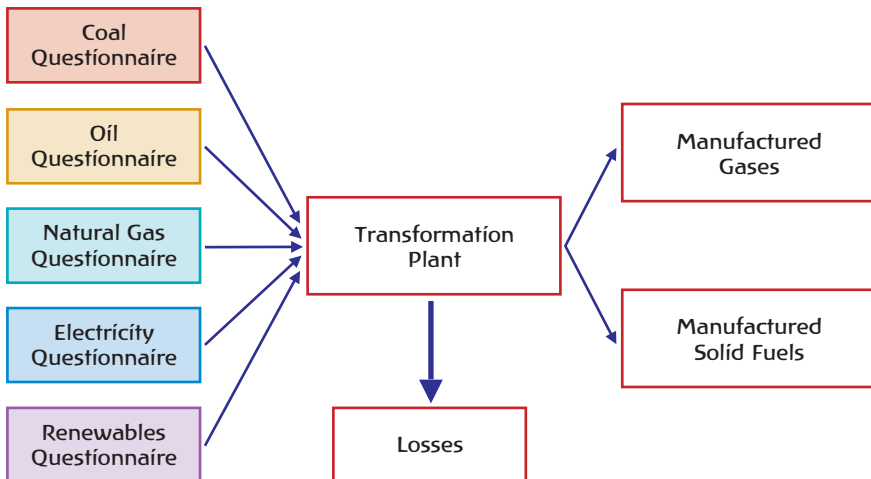

■ **Essential**

Report In the transformation sector inputs of energy which are transformed into other forms of energy.

Some transformation processes include input energy that is reported on other fuel questionnaires.

Consumption of coal in the energy sector.....

General information

Besides the transformation plants listed above, solid fossil fuels and manufactured gases can be used by the energy industry to support energy production. This is for instance the case for coal mines which consume coal to support the extraction and preparation of coal within the coal-mining industry. Consumption of the energy sector could include fuel used for heating, lighting, or operating pumps/compressors, or used as input fuel into furnaces or ovens. The consumption of the energy sector includes "own use".

Manufactured gases are also widely used to support energy transformation activities. For instance, globally, about 20 to 25% of coke-oven gas is used as input fuel for the coke ovens. Blast-furnace gas is used to heat the blast furnace, as well as for heating coke ovens, and gas-works gas is used to support the operation of gas works.

Specific information related to the joint questionnaire

Inputs of fossil fuels and manufactured gases into the energy sector to support transformation processes are reported in the second part of Table 1.

Report in the *Energy Sector* the quantities of energy commodities consumed within the fuel and energy enterprises in the sense that they disappear from the account rather than appear after transformation as another energy commodity. The commodities are used to support the various activities within the fuel extraction, conversion or energy production plant but they do not enter into the transformation process.

The quantities are to be reported in thousand tonnes for solid fossil fuels and in terajoules for manufactured gases. All values have to be rounded to zero decimal places and negative values are not allowed.

Essential

In the energy sector, only report fuels used by the energy industry to support the extraction or transformation activity.

Coal transport and distribution losses.....

General information

The transportation and distribution of coals and solid fossil fuel products often involve multiple episodes of handling and storage. In the course of this activity, solid product is lost from the supply stream in a number of ways. For example, coals shipped by rail experience some small losses during their movement in open hopper cars. Solid fuels can also be lost during accidents and derailments on rail lines or in marshalling yards. During storage, coals and solid fuels tend to "settle"

at the storage site(s) and a residue of fuel is left in the soil or on the pads of the storage site. Small amounts of solid fuels can also be lost from storage sites and conveyor belts as “fugitive” dust.

Manufactured gases are lost during distribution within the facilities that produce and use them. These losses are due to leaks, and sometimes to accidental or deliberate venting that occurs in the normal course of operations. Because of the short distances over which manufactured gases are distributed, these losses seldom reach the magnitude experienced for natural gas, which is often transported over long distances.

Because of the large share of coal in total solid fossil fuels and manufactured gases, and the use of ships for transporting coals, transport and distribution losses are much more limited than in the case of oil, gas and electricity, for which major losses occur in pipelines, gas lines and electric lines. For sake of comparison, losses worldwide account for less than 0.04% of coal supply compared, for instance, to 8.7% for electricity, and 1% for natural gas.

As a consequence, transport and distribution losses are likely to be minimal for solid fuels, and apply mainly to manufactured gases. They should be independently estimated by the reporting enterprises and not be calculated to balance the account.

Specific information related to the joint questionnaire

Losses are to be reported in part three of Table 1 just underneath the Energy Sector section.

If the statistical difference for any product is zero, then check with the reporting entity whether reported losses are effectively the statistical difference and confirm that no independent measure of the losses exists.

Manufactured gases which are flared (burned rather than consumed in other sectors) should be reported in the *Other Energy Sector Use*, and not in the transport and distribution losses. However, gases which are vented should be reported in *Distribution Losses*.

Losses are to be reported in thousand tonnes for solid fossil fuels and in terajoules for manufactured gases. All values have to be rounded to zero decimal places and negative values are not allowed.

Essential

All quantities of fuels lost owing to transport and distribution should be reported in distribution losses.

Manufactured gases which are flared should be reported in the energy sector.

Gases which are vented should be reported in distribution losses.

Final consumption.....

General information

Final consumption is all coals and coal products delivered to final consumers in the industry, transport, other sectors as well as non-energy. It excludes solid fossil fuels and manufactured gases used for transformation and/or own use of energy-producing industries.

Final energy consumption of coals and coal products outside the transformation sector is primarily in the industry sector. Around 15% of total coal supply is reported as energy input into the industrial sector. The largest use of coal in the industry sector is for manufacture of cement, where coal is used as an energy source for cement kilns. Other large industry sub-sectors that consume coal are the chemical and petrochemical sector, the iron and steel sector, the food and tobacco sector and the paper and pulp sector.

In the past, a large quantity of coal was consumed in the transport sector (by ships and rail locomotives); this consumption has declined to an insignificant level in most countries. The share of transport only accounts for 0.2% in global coal demand.

Other sectors, mainly services and residential, where coal is used for heating purposes, as well as for cooking in some countries, account for 0.5% of total coal demand.

Solid fossil fuels and manufactured gases are also used as non-energy (feedstock). The former can be used, for instance, to make methanol or ammonia. Coal is also used in the petrochemical sector as a feedstock for other petrochemical products. Further, finely divided coke is used in the manufacture of building materials, and for carbon in anode manufacture and some other chemical processes. However, the use of coals and coal-based products for non-energy purposes is very small – representing less than 0.1% of coal consumption.

Specific information related to the joint questionnaire

Quantities of coals and coal products used for energy purposes should be reported in the appropriate sector of Table 1.

Energy products used as non-energy raw materials should also be reported in Table 1 under *Non-energy Use*. These are products consumed as feedstocks rather than as fuel or transformed into another fuel.

The figures reported in the *Industry Sector* for the consumption of fuels by enterprises should include heat generated for self-use, fuels for process steam, furnaces, ovens and similar facilities. The figures reported for the consumption of fuels by enterprises should exclude quantities used to generate electricity and heat sold to third parties, and any coal and coal products used for non-energy purposes. These quantities should be reported in the *Transformation* and *Non-energy Sectors* respectively. In the case of iron and steel, fuels used in blast furnaces should be reported in the *Transformation Sector* in order to avoid double counting.

Final energy consumption, non-energy use and feedstock use should be reported in thousand tonnes for solid fossil fuels and in terajoules for manufactured gases. All values have to be rounded to zero decimal places and negative values are not allowed.

Essential

Coal and coal products can be used for energy and non-energy purposes.

Report both uses in the appropriate sector and sub-sector.

7 Additional Requirements for the Joint Questionnaire on Coal

Calorific values.....

General information

Each solid fossil fuel is characterised by its own calorific value, i.e. the quantity of energy available in a unit of mass (Annex 3, Section 5). For instance, hard coal refers to coal of gross calorific value greater than 23 865 kJ/kg and brown coal refers to non-agglomerating coals with a gross calorific value less than 17 435 kJ/kg.

Accurate calorific values are essential to construct reliable energy balances since the balances are established on energy and not on commodity units. As a consequence, it is essential to make available calorific values not only for the fuels produced, but also for the fuels traded and used for several major purposes. Calorific values are also used in the process of estimating CO₂ emissions, and for checking the thermal efficiencies of transformation processes.

If it is impossible to collect the calorific values from each mine, fuel-burning facility or from each import origin and/or export destination. Representative averages (based, for instance, upon the largest producing mines or the total imports and/or exports of a category of coal) can be considered as appropriate for reporting.

Figure 5.4 ● Calorific Values

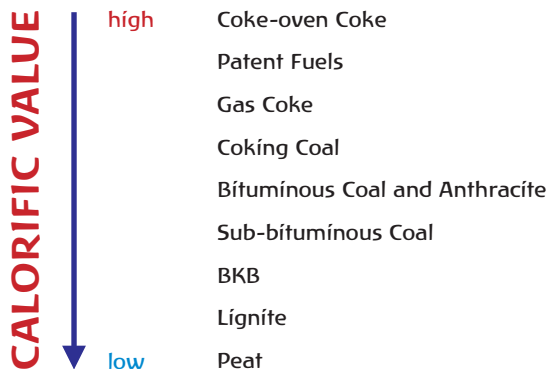

Specific information related to the joint questionnaire

Table 4 requests both gross and net calorific values for the fuels as produced, traded and used for several major purposes (see Chapter 1, *Fundamentals*, Section 6 for a complete description of net and gross calorific values).

In cases where calorific values for the individual supplies and uses are not available, the average value over all uses should be given. Similarly, if gross calorific values for coals are not available, then they may be estimated by adding 5% to the net value. There are negligible differences between gross and net calorific values for cokes and blast-furnace gas. However, for gas-works and coke-oven gases, net calorific values are about 11% less than gross. (See Annex 3, Section 5 for typical calorific values for solid fuels and derived gases.)

The values should be expressed in megajoules per tonne (MJ/t) and should represent the calorific values for the fuels in their conditions as supplied or used. All values have to be rounded to zero decimal places and negative values should not be reported.

Essential

Gross and net calorific values should be provided for each solid fuel product reported.

Gross calorific values for coal can be estimated from net values by adding 5% to the net calorific value.

Production, employment and productivity of labour in coal mines

General information

The coal sector has experienced a substantial restructuring in many countries during the last decades. This has been accompanied by a shift from underground to surface mining from labour-intensive to more mechanised mining in both underground and surface mines, and by a rapid increase of productivity. In order to monitor the evolution of the coal sector, socio-economic data related to mine type, labour productivity and employment in coal mines need to be combined with traditional production, trade and consumption statistics.

While the data on employment and productivity are not necessary to construct a traditional commodity or energy balance, they are essential to fully understanding the coal sector.

Specific information related to the joint questionnaire

Production: The quantities reported are the amounts extracted or produced, after any operation for removal of inert matter. In the coal-mining industry, this is generally referred to as “clean” or “saleable” production. Production includes the

quantities consumed by the producer in the production process. Production should be broken down between underground and surface productions defined as follows:

- **Underground production** of each coal category (hard coal and brown coal) should equal the *sum of the components* reported on Table 1. For example, the sum of *Coking Coal*, and *Other Bituminous Coal and Anthracite*, reported on Table 1 “of which underground” should equal *Underground Production of Hard Coal* reported on Table 5.
- Similarly, **surface production** of each coal category (*Hard Coal* and *Brown Coal*) in Table 5 should equal the *sum of the components* reported on Table 1. For example, the sum of *Sub-bituminous Coal* and *Lignite/Brown Coal* reported on Table 1 “of which surface” should equal *Surface Production of Brown Coal* reported on Table 5.

Recovered slurry (other sources) of each coal category (*Hard Coal* and *Brown Coal*) in Table 5 should equal the *sum of the appropriate components* reported on Table 1. For example, the sum of *Coking Coal*, and *Other Bituminous Coal and Anthracite*, reported on Table 1 “Recovered slurry (other sources)”, should equal *Hard Coal* reported in *Recovered slurry (other sources)* on Table 5.

Mine: The activities included within the “mine” used for calculating mines’ consumption, employment and productivity embody all operations connected with getting, raising, handling, preparing and transporting coal from the face or the production pits to the point of despatch to third parties. This includes activities necessary for maintaining the environment of the mine; activities necessary for on-site maintenance and repair of equipment connected with operations; and activities connected with the disposal of waste products from mining operations.

Ancillary activities, such as coke ovens, patent fuel plants, brickworks and power plants supplying electricity primarily for external sale are excluded. Power plants supplying principally to the mine are included, as are workshops, warehouses and stockyards located at the site of the mine. Centralised workshops serving groups of mines are excluded. All coal preparation plants, and surface transport (railways, lorries, conveyors, aerial ropeways, etc.) handling coal before it is loaded, moving and disposing mining waste and transporting coal to a centralised coal preparation plant are part of the mine. Surface transport handling coal after it is prepared, such as moving the coal to centralised depots, is not part of the mine. Surface mobile plant (fork-lift trucks, cranes, etc.) working within a stockyard or moving materials from stockyard to mine operations are part of the mine activity, but transport bringing materials from external suppliers to the mine stockyard are not.

Welfare services such as canteens, shops and supermarkets at collieries, maintenance of mineworkers’ dwellings, sports and recreational facilities, and medical clinics are not part of the mine, although a first-aid room for immediate treatment of injuries is considered as part of the mine.

Workers at mines (men on colliery books): All personnel who are engaged in mines’ activities as defined above, but excluding those persons performing solely clerical or administrative duties. Workers are those employees engaged in the implementation of the production processes or who provide auxiliary services to the production processes, such as maintenance work or craft tradesmen. In contrast,

the non-manual workers excluded from these data are those employees engaged more with the paperwork rather than the manual work and comprise managers, scientific staff (including laboratory staff), technical staff (such as engineers and surveyors), commercial staff (accounting, sales, etc.), administrative staff (e.g. personnel officers), office staff (clerks, timekeepers, typists) and computer staff. Supervisory staff and officials are included, other than those in charge of staff engaged on purely clerical or administrative duties. Contractors' men engaged on operations of the mine are included.

All workers on the books of the mine are included, whether full-time or part-time workers. Persons who have not reported for work for more than six months as a result of protracted illness, military service or other reasons are not included.

Average annual number of workers: This average is generally calculated from the numbers at the end of 13 months (or 53 weeks), starting with the number at the end of the last month (or the last week) of the year preceding the year under review.

Manshifts: A manshift is the normal period of attendance at the mine of one working day. The duration of a shift varies both between and within countries according to the labour arrangements and regulation in force. The figures of shifts comprise all shifts worked by workers on the books, defined in terms of normal shifts, overtime being expressed "pro rata" in terms of normal shifts based on the overtime hours actually worked, not those paid for.

Average annual number of shifts worked, per worker: This average is the total number of shifts worked by workers on the books during the year, divided by the average annual number of workers.

Average duration of a shift: The duration of a shift is not the effective working time spent at the workplace, but the total time during which it is necessary for the worker to be at the mine. Working time includes any time waiting to be deployed to a specific task, meal and rest breaks taken within the period of the shift, and also all the time spent in travelling or waiting for manriders. The duration of working time is calculated in decimal hours.

Surface and underground productivity: Productivity is calculated from the production of coal related to productivity, and from the manshifts worked by workers at mines, both as defined above. In addition, **the following items** (both from output and manshifts) **are excluded:**

- **Recovery of coal from dumps** – Comprises the recovery of hard coal from spoil heaps and the dredging of slurry from old settling ponds. (Slurries from the preparation process of currently produced coal from deep mines are included in output results provided they are sold or used at the mine.)
- **Small mines** – They are mines which are not significant in the coal economy and where the effort in collecting the data is out of all proportion with the effect on overall results.
- **Work on capital investment projects** – This covers activities over and above those required for maintaining existing production activities.

Both the manshifts worked on capital investment projects and any coal produced from such operations are excluded when calculating productivity.

Any subsequent driving of gate roads, making cross cuts, equipping newly established face, or drivage of roadway for an advancing face are normal production operations. In surface mines, extension of roads and other conveyance is part of operations and is included in the productivity calculations.

The productivity calculation relates to all workers of the mine, whether employed directly by the colliery or by an outside contractor. It also includes the work of supervisory staff, and trainees if their efforts contribute to the regular mining operations.

Regular mining work for which all shifts are included in productivity includes:

- Coal winning.
- Roadway drivage except where classified above as capital investment.
- Equipping and dismantling of faces.
- Operation of equipment at surface production pits.
- Haulage and transport, whether for coal, materials or men.
- Maintenance and repair of roadways and other workings.
- Maintenance and repair of equipment, *in situ*, underground and at surface production pits. Where a machine requires major repair, the dismantling, transport and reinstallation of the machine are all included in the productivity calculation.
- Safety, health and ventilation work, such as dust sampling, prevention of mine fires, etc.

Essential

Follow carefully the specific information given above to fill up Table 5 of the questionnaire.

Inputs to autoproducer electricity and heat generation

General information

With the growing importance of the environmental debate, it has become essential to identify total consumption of fuels in each respective industry and consuming sector, so that for each sector appropriate measures can be developed to conserve energy and reduce greenhouse gas emissions.

For general information and definitions for autoproduction, please refer to Chapter 2, *Electricity & Heat*, Section 1.

Specific information related to the joint questionnaire

Inputs to autoproducer electricity and heat production are reported on Table 6a to 6c.

This table provides information on the fuel used by autoproducers of electricity and heat for sale according to their principal economic activity. The table is separated into three parts corresponding to three recognised types of generating plant; *Electricity-only*, *CHP*, and *Heat-only*. The data are used for tracking fuel inputs and electricity and heat outputs by autoproducers as part of the United Nations efforts to understand CO₂ emissions.

In the case of CHP plants, reporting separate figures for the amounts of fuel used for the production of electricity and heat requires a method of dividing the total fuel use between the two energy outputs. The division is required even if no heat is sold because the fuel used for electricity production must be reported in the *Transformation Sector*. The method proposed is described in *Annex 1*, Section 1 of the *Manual* and should be followed carefully.

Please note that the totals reported in Table 6 should equal the respective totals reported in the *Transformation Sector*. Also note that a similar table is included with the *Electricity and Heat Questionnaire* (Table 9). To avoid inconsistent reporting, please contact the person responsible for the completion of the *Electricity and Heat Questionnaire* in your country.

Essential

Report coal and coal products used by autoproducers as input for electricity and heat production in the respective sectors.

Renewables & Waste



1 What are Renewables and Waste?

General information

One can find numerous definitions of renewables in technical literature, including the following one: **renewable energy** is energy that is derived from natural processes that are replenished constantly. Although this definition leads to some issues, dealing for instance with the time horizon for the replenishment, it will be used as the reference in this chapter.

There are various forms of renewable energy, deriving directly or indirectly from the sun, or from heat generated deep within the earth. They include energy generated from solar, wind, biomass, geothermal, hydropower and ocean resources, solid biomass, biogas and liquid biofuels.

Waste is a fuel consisting of many materials coming from combustible industrial, institutional, hospital and household wastes such as rubber, plastics, waste fossil oils and other similar commodities. It is either solid or liquid in form, renewable or non-renewable, biodegradable or non-biodegradable.

A detailed list of the renewable energy and waste sources and associated technologies which are economically viable or approaching economic viability is provided in the *Glossary*.

Solid biomass (mainly fuelwood used for cooking in developing countries) is by far the largest renewable energy source, representing more than 10% of world total primary energy supply (TPES), or three-quarters of global renewables supply.

Since 1990, renewable energy sources in the world have grown at an average annual rate of 1.7%, which is slightly higher than the growth rate of world TPES. Growth has been especially high for “new” renewables (wind, solar), which grew at an average annual rate of 19%, and the bulk of the increase happened in OECD countries, with large wind energy programmes in countries such as Denmark and Germany.

The discussions on climate change have undoubtedly stimulated the development of renewable energy in order to reduce the emissions of greenhouse gases from Annex 1 Parties to the United Nations Framework Convention on Climate Change (UNFCCC); therefore, there is a strong need for better monitoring this development and consequently to strengthen the reporting and dissemination of timely and reliable information on renewables and waste. This is a major challenge since a large part of renewable energy is not commercially marketed (fuelwood, solar collectors) and/or is located in remote areas.

Specific information related to the joint questionnaire

The *Renewables and Waste Questionnaire* classifies the renewable and waste products into three main groups:

- Group I includes products which need to be transformed into electricity in order to be captured (such as hydro or solar photovoltaic).
- Group II includes products which are produced and then can be input for multiple uses in the transformation and final consumption sectors (such as geothermal or solar thermal); because of their nature, these products cannot be stored in a conventional sense, and therefore are products for which no stock change data can be reported.
- Group III includes products which are produced and used for multiple purposes in the transformation and final consumption sectors (such as wastes, fuelwood, biogas and liquid biofuels); because of their nature, they can be stored in a conventional sense, and are products for which stock change data can be reported.

Another point is that industrial waste and non-renewable municipal solid waste should be reported on the annual *Renewables and Waste Questionnaire* despite the fact that the IEA and the European Union methodologies exclude these types of waste from the definition of renewable energy.

Figure 6.1 ● *Renewables and Waste Classification into Three Groups*

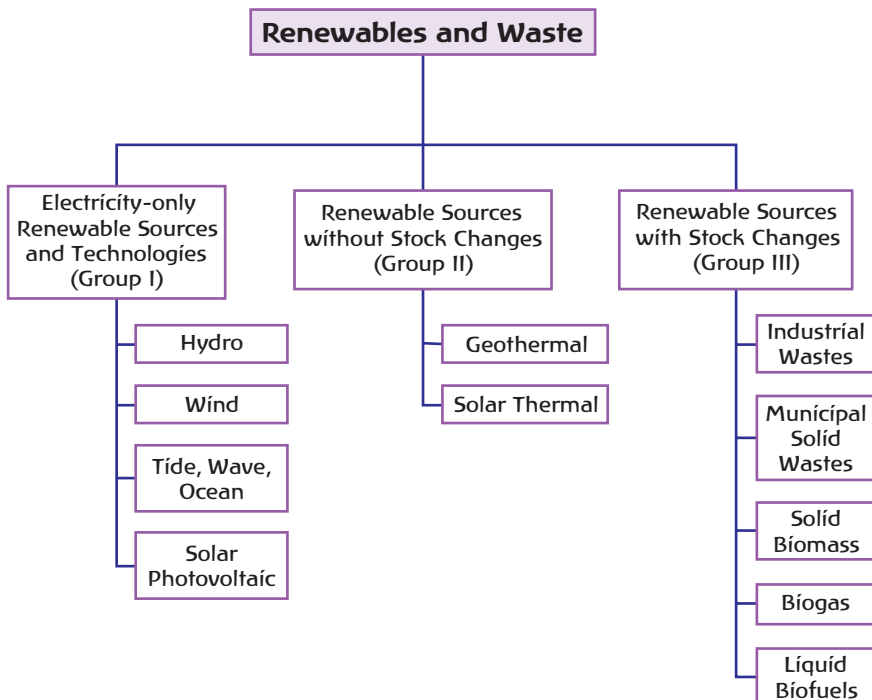

Special attention should be given to the following items: **municipal solid waste** and **passive solar energy**. They should be treated in the questionnaire as described below.

Municipal solid waste (MSW): Some controversy is present in the definition of municipal solid waste. This stems from the fact that waste collected from households, commercial establishments, hospitals and other institutions contains components that are both biodegradable and non-biodegradable. Both IEA and European Union definitions of renewables exclude non-biodegradable municipal solid waste; however, some member countries count all MSW as renewable. In other member countries, surveys are under way to determine what fraction of MSW is renewables. Finally, ongoing implementation of recycling programmes, separation at the point of combustion and other techniques are expected to reduce the fraction of non-biodegradable MSW.

If it is not possible to distinguish between renewable and non-renewable municipal solid wastes, then the total quantity should be divided equally between both categories.

Passive solar energy: Passive solar energy is encouraged in many countries, and its applications have become widespread. However, since many member countries do not collect data on passive solar design and facilities, and since it is often impossible to collect or estimate flows, passive solar energy is not included as a product for the questionnaire.

Essential

Renewable energy is derived from natural processes that are replenished constantly.

Renewable and waste energy products are divided into three main groups: electricity-only, sources without stock changes and sources with stock changes.

The questionnaire also includes waste products.

Passive solar energy is not included as a product for the questionnaire.

2 What Units are Used to Express Renewables and Waste?

General information

Because of their diverse forms, renewables and waste products have traditionally been measured in a variety of units. Solid products like wood and wood waste are often measured in volume (cubic metres or cords) and mass (tonnes) units. Biogases can be measured on a volume basis (cubic metres) and on an energy content basis (therms or kilowatt-hours), and bioliquids in terms of volume (litres), mass (tonnes) and/or energy content (joules or megajoules).

Further, electricity-only renewable sources and technologies like hydro, solar-photovoltaic, tide, wave, ocean and wind can be measured only in terms of electricity output (usually kilo-, mega- or gigawatt-hours).

Specific information related to the joint questionnaire

One objective of the *Renewables and Waste Questionnaire* is to set standardised units for measurement of renewables and waste products in order to facilitate the processing and the comparison of the data.

The units in which quantities should be expressed are the following:

- *For electricity:* Production is expressed in gigawatt-hours (GWh) and generating capacity in megawatts (MW_e). However, in the case of a solar power plant, the solar collectors surface has also to be reported (in 1000 m²), and in the case of a liquid biofuels plant, the liquid biofuels plant capacity has also to be reported (in tonnes/year).
- *For heat:* Production is expressed in terajoules (TJ).
- *For all the other flows (Supply, Transformation and Energy Sectors end uses)* the units in which quantities of fuels are expressed are terajoules (TJ) except for *Charcoal* and *Liquid Biofuels* which are reported by mass (in thousand tonnes).

Total energy content of the fuels reported in terajoules should be calculated using the **net calorific value** of the respective fuels. All values have to be rounded to zero decimal places and negative values are not allowed.

Essential

Values for electricity generation are reported in gigawatt-hours (GWh).

Values for heat generation are reported in terajoules (TJ).

Energy values for most fuels are reported in terajoules (TJ).

Exceptions are charcoal and liquid biofuels that are reported in 1000 tonnes.

3 How to Make the Conversion from Mass and Volume to Energy

General information

Fuelwood and other solid fuels derived from vegetal matter can be reported in many different ways depending on the fuel, the use and the country. The units can be very general such as bundles of wood, or more precise when linked to volume or mass terms, such as cords, cubic metres, and tonnes.

However, in order for one to be able to use these data in a comparable way with other fuels, there is a need to convert the data to energy units. This is not always an easy process since several factors such as density and humidity (e.g. for fuelwood) have a major impact on the conversion factor used.

The same applies to gaseous fuels which are often reported in volume terms like cubic metres or cubic feet. In these cases, the volume value should be multiplied by an energy-per-unit-of-volume factor to derive the total energy content.

It is also possible that liquid biofuels would be reported in litres, kilogrammes or barrels. In such cases, the volume of biofuel should be multiplied by a mass-per-unit-of-volume factor to derive the total mass of the product.

For general information on conversion and conversion factors, please refer to Chapter 1 *Fundamentals*, Section 5, *How to Measure Quantities and Heating Values* and Annex 3 – *Units and Conversion Equivalents*.

Specific information related to the joint questionnaire

Whatever conversions must take place before completing the questionnaire tables, values for electricity generation are reported in gigawatt-hours (GWh); and values for heat generation and most fuels are reported in terajoules (TJ).

Total energy content of the fuels reported in terajoules should be calculated using the **net calorific value** of the respective fuels.

The exceptions to this general rule are for *Charcoal* and *Liquid Biofuels* that are reported in 1000 tonnes. However, for these two fuels there is a need to report average net calorific values in Table 4. The calorific values dramatically vary from biofuel to biofuel, as well as in function of the type of charcoal, the density and the humidity. Since it is not possible to have specific calorific values for each flow and product, statisticians must average the value based on a representative breakdown of biofuels and charcoal.

Essential

Report product flows in energy units: gigawatt-hours (GWh) for electricity and terajoules (TJ) using net calorific values for others, except for biofuels and charcoal to be reported in mass (1000 tonnes).

4 Renewables and Waste Flows

General information

A deliberately simplified flow chart for the three groups of renewables and waste products, from production to consumption, is shown in Figure 6.2. The differences in the supply flow among the three groups of renewables and waste will be discussed in Section 5 below.

Figure 6.2 • Simplified Flow Chart for Renewables and Waste

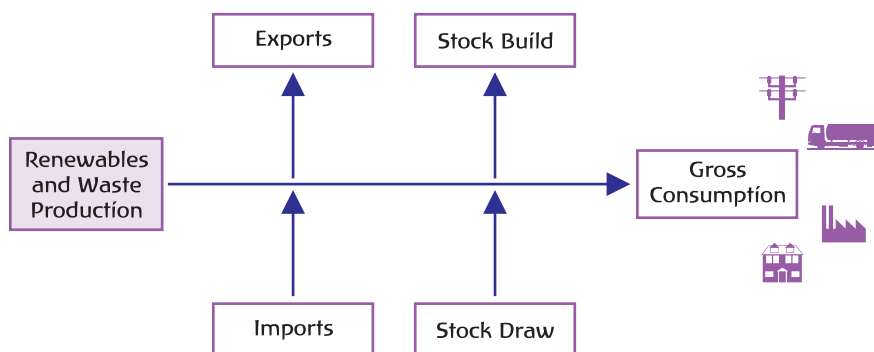

Specific information related to the joint questionnaire

The *Renewables and Wastes Questionnaire* consists of six tables on which flows are reported. The nature of each table is as follows:

- Table 1: Gross Electricity and Heat Production.
- Table 2: Supply, Transformation and Energy Sectors.
- Table 3: Energy End Use (final consumption by sector).
- Table 4: Technical Characteristics of Installations.
- Table 5: Inputs to Autoproducer Electricity and Heat Generation.
- Table 6: (Analysis of) Production of Wood, Wood Wastes, Other Solid Wastes.

Each of the above tables will be presented in the next paragraphs. However, there are a number of key data and totals which must be preserved across the various tables. These are illustrated in Figure 6.3 .

It is essential that the figures reported in each table are correctly totalled and that the totals in different tables are consistent wherever a logical relationship exists. Namely, the following totals have to be consistent between the various tables:

- *Production of Wood/Wood Wastes/Other Solid Wastes* in Table 2 can be detailed further in Table 6. When Table 6 is completed, total production must equal production in Table 2.
- The *sum of data* reported on Table 5a to 5c must be consistent with data reported in the Transformation Sector for each product in Table 2.

It is also essential that individual entries and totals that appear on other annual questionnaires are consistent wherever a logical relationship exists:

- *Statistics for Gross Electricity and Heat Production* reported in Table 1 should match gross electricity and heat production reported for the same flows on the annual *Electricity and Heat Questionnaire*.
- *Transfer of products to industries* covered by other fuel questionnaires (mainly liquid biofuels) are reported on Table 2 and must be consistent with transfers reported on the *Oil Questionnaire* on Table 1.

Figure 6.3 • Table Relations within the Renewables and Waste Questionnaire

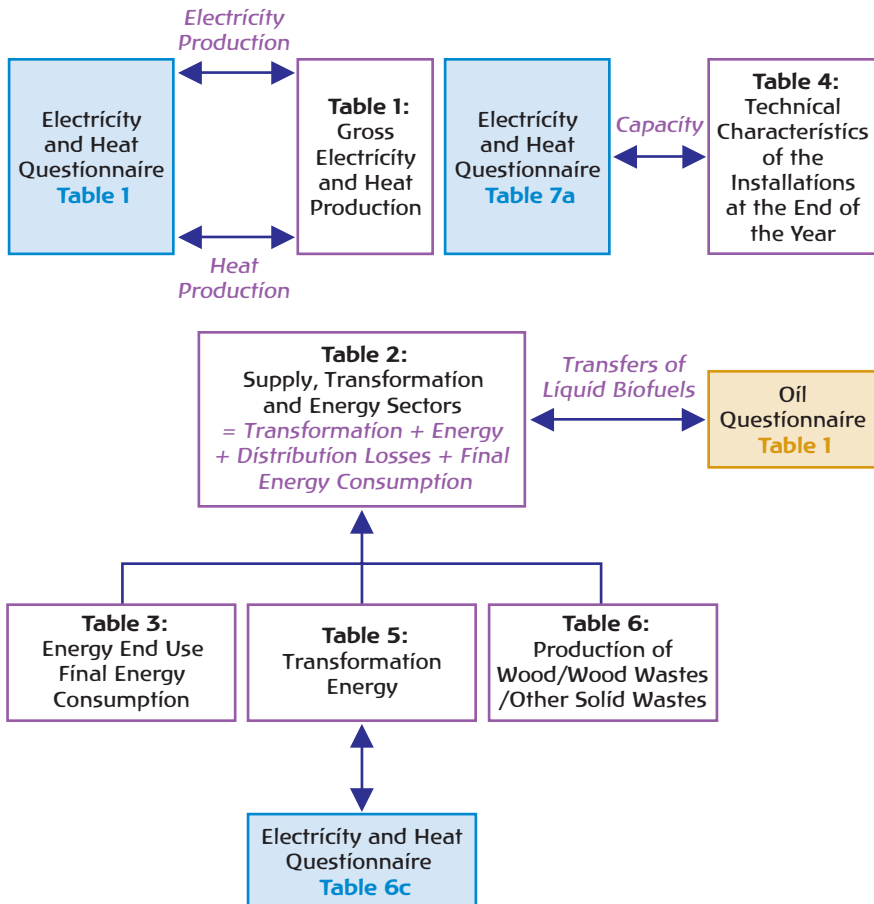

- *Inputs reported in the Transformation Sector for electricity and heat production must be consistent with inputs reported on Table 6 of the Electricity and Heat Questionnaire. Electricity and heat inputs reported on Table 2 should also be consistent with those reported for autoproducers in Table 5a to 5c of the Renewables and Waste Questionnaire.*
- *The electrical capacities reported in Table 4 must be consistent with the capacities reported for each technology on Table 7 of the Electricity and Heat Questionnaire.*

Essential

Please remember the interrelationships between the tables in the questionnaire. Key totals should be consistent.

5 Renewables and Waste Supply

As defined in Section 9 of Chapter 1, *Fundamentals*, supply includes production, trade and stock changes. Each of these three components will be detailed in the next paragraphs.

Owing to various natures of renewables and waste products, the flows from production to consumption are slightly different since, for example, wind and solar photovoltaic energies are used exclusively for electricity production, geothermal and solar thermal energies are not subject to stock changes whereas solid, liquid and biogas materials are.

Production.....

General information

As highlighted in the definition of renewables and waste products (Section 1 of this chapter), some of the products (hydro, solar photovoltaic) need to be transformed into electricity in order to be captured. As a consequence, energy production from these products, listed as Group I above, is limited solely to electricity production at this time.

Because of product diversity, renewables and waste production is quite diverse. Other renewables and waste technologies, listed as Group II and Group III above, are produced separately, and can be used for electricity and heat generation or directly consumed for other energy purposes.

The production of Group II products is based upon capture of thermal energy from the earth's crust or from the radiation of the sun. Geothermal production utilises steam or hot water recovery technology. Thermal solar production utilises solar collectors to warm a transfer medium, and that heat is then used for other energy purposes.

Group III products involve diversion of biodegradable or non-biodegradable materials from the industrial or municipal waste stream, production of primary biomass materials or conversion of primary biodegradable materials (like wood pulp, sewage sludge, landfill waste) into secondary energy products. For instance, fuelwood can be burnt in a steam power plant to produce electricity and heat, transformed into charcoal, or consumed in a three-stone stove for cooking.

Specific information related to the joint questionnaire

Statistics are collected on gross electricity and heat production to enable capturing Group I production statistics, as well as to separate this activity for Group II and Group III products.

Production from Group I products is based entirely on electricity generation and is reported in Table 1 related to Gross Electricity and Heat Production. This is the case of hydro production.

As regards Group II and Group III products, their production is reported in Table 2. However, when these products are transformed in electricity and heat, the quantity of electricity and heat generated by the transformation are reported in Table 1.

Figure 6.4 • Simplified Flow Chart for Group I Renewables and Waste

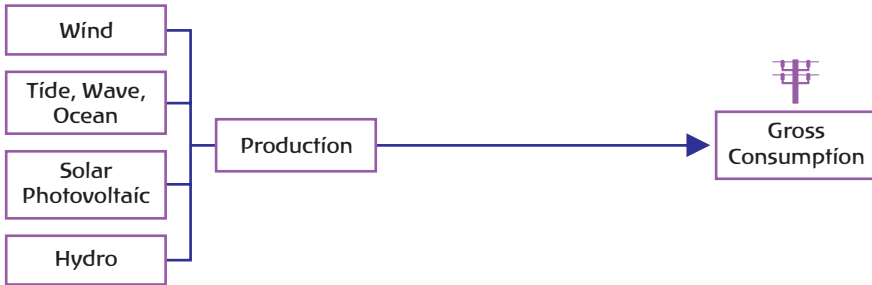

Figure 6.5 • Simplified Flow Chart for Group II Renewables and Waste

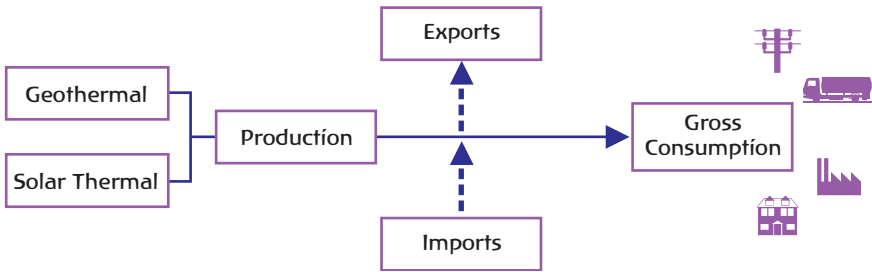
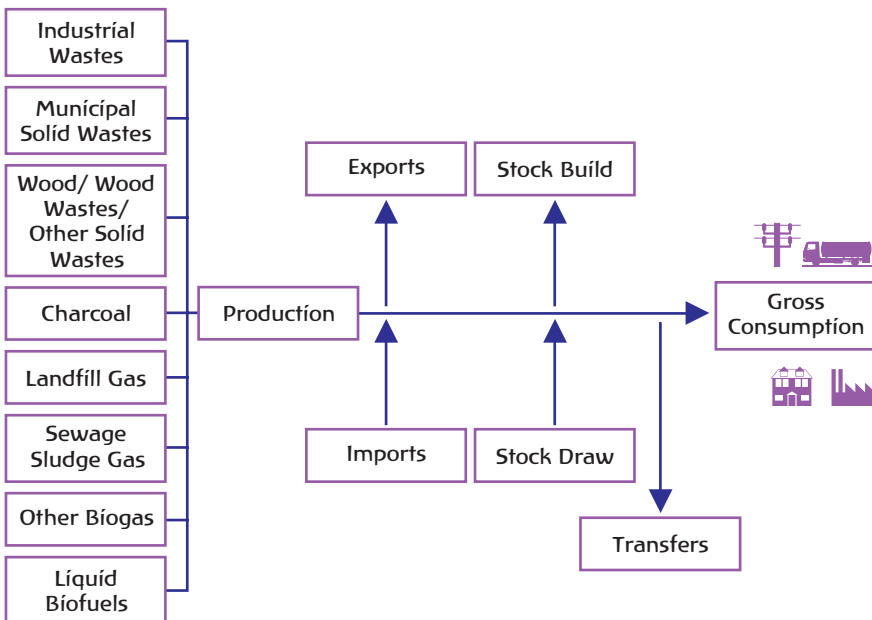

Figure 6.6 • Simplified Flow Chart for Group III Renewables and Waste



Production of geothermal energy is measured by subtracting the heat of the fluid reinjected into the earth's crust from the heat of the fluid or steam upon its extraction from the earth's crust. Solar thermal production is the heat available to the heat transfer medium minus the optical and collector heat losses.

Solid biomass production is the net calorific value of the heat content of the material used for fuel. The exception in solid biomass is charcoal, in which production is the mass of the material after carbonisation.

Industrial and municipal solid waste is the net calorific value of the heat content of the material used for fuel.

Production of biogas corresponds to the net calorific value of the heat content of the biogas, including gases consumed in the fermentation implement, but excluding flared gases.

Production of liquid biofuels is the mass of the finished product exiting the production equipment.

Amounts are to be reported in gigawatt-hours (GWh) for electricity, terajoules (TJ) for heat and 1000 tonnes for charcoal and liquid biofuels. All values have to be rounded to zero decimal places and negative values are not allowed.

Essential

Production of Group I products is reported on Table 1.

Production of other products is reported on Table 2.

Imports and exports

General information

The imports and exports of renewables and waste are still very limited. There are several reasons for the low development of trade in renewables and waste between countries and worldwide.

First, because production under Group I is based entirely on electricity and heat generation. As a consequence, any trade related to this production is not a trade of renewables and waste as such but as an electricity and heat trade. It is still very difficult (or impossible) to identify the source of traded electricity. However, the opening of green markets for the electricity might force statisticians to be in a position to break down imports and exports of electricity by source of production.

Secondly, supply of Group II products involves extraction and further use of heat derived from the earth's crust or the sun; as a consequence, imports and exports could only involve movement of the product (in this case, in the form of heat) across national boundaries. This is unlikely to happen.

Imports and exports of Group III products could therefore constitute the only real possibility for trade for renewables and waste. For instance, fuelwood and agro-

residues could cross borders. However, the low calorific value of most of these products does not make the transport of these products economic over long distances. Therefore, trade of Group III products is also very limited.

Specific information related to the joint questionnaire

Total trade is to be reported in Table 2. For renewables and waste products, since trade is limited, there is no need to collect and report imports by origin and exports by destination.

Imports and exports relate to the quantity of fuel that crosses the political boundary of a country. A product is considered imported or exported, whether or not customs clearance has taken place, if it crosses a national political boundary.

Trade of electricity generated from renewables and waste is reported under electricity as part of total electricity trade, and not under renewables and waste.

Amounts are to be reported in terajoules (TJ) for heat and 1000 tonnes for charcoal and liquid biofuels. All values have to be rounded to zero decimal places and negative values are not allowed.

Essential

The imports and exports of renewables are extremely limited; they mainly concern Group III products.

Stock changes.....

General information

What has been mentioned on trade also applies to stocks. Indeed, the stocks (and stock changes) of renewables and waste are still very limited, for several reasons.

Production under Group I is based entirely on electricity and heat generation, making storage of these two energy carriers very difficult. Potential hydro production from pumped storage should not be considered as stock.

Group II includes products that can be input for multiple uses in the transformation and final consumption sectors (such as geothermal or solar thermal); however, because of their nature, these products cannot be "stored" in a conventional sense, and therefore are products for which no stock change data can be reported.

Group III includes products that are produced and used for multiple purposes in the transformation and final consumption sectors (such as wastes, fuelwood, biogas and liquid biofuels); because of their nature, they can be "stored" in a conventional sense. As a consequence, they are the only products for which stock change data can be reported.

Moreover, stocks of fuelwood and agro-residues are not stable over time because of several phenomena, such as production of methane, and consequently are often seasonal and depend on the culture (sugar cane, palm oil, etc.).

Lastly, since the quantities of stocks are very limited and locations very remote, it is extremely difficult to have a precise idea of the stocks of renewables and waste, and therefore of the stock changes.

Specific information related to the joint questionnaire

Only stock changes are to be reported in Table 2. A stock change is equal to opening stock levels minus closing stock levels, i.e. a negative number indicates a stock build, a positive number indicates a stock draw.

Opening stocks are the stock levels as of the first day of the time period requested; closing stocks are the stock levels at the end of the time period. For example for a calendar year, opening stocks are the stock levels on 1 January, closing stocks are measured on 31 December.

Amounts are to be reported in terajoules (TJ) for heat and 1000 tonnes for charcoal and liquid biofuels. All values have to be rounded to zero decimal places and negative values are not allowed.

Essential

The stock changes of renewables and waste are extremely limited; they mainly concern Group III products.

Products transferred

General information

Quantities of liquid biofuels that are passed to refineries, or other types of oil product facilities and used for blending with or as additives to other oil products, are transferred. These are fuels that are not delivered for final consumption, but are blended or added before final consumption of the oil product.

They include for instance biofuels which are used for the preparation of biodiesel.

Specific information related to the joint questionnaire

Report quantities of liquid biofuels that are not delivered to the final consumption but are used with other petroleum products reported in the *Oil Questionnaire*.

Since transfers only apply to liquid biofuels, amounts are to be reported in 1000 tonnes. All values have to be rounded to zero decimal places and negative values are not allowed.

Essential

Transfers only apply to liquid biofuels.

6 Renewables and Waste Consumption

Group I products lead to direct generation of electricity and heat. As a consequence, the consumption of these products does not fall under the analysis of renewables and waste consumption but under the analysis of the overall electricity and heat consumption.

As regards the consumption of Group II and Group III renewables and waste products, it occurs in several sectors:

- In the transformation sector.
- By the energy industry within the energy sector.
- In the various sectors and branches of final consumption (industry, transport, residential, services, agricultural, etc.).

Figure 6.7 ● Renewables and Waste Consumption by Sector

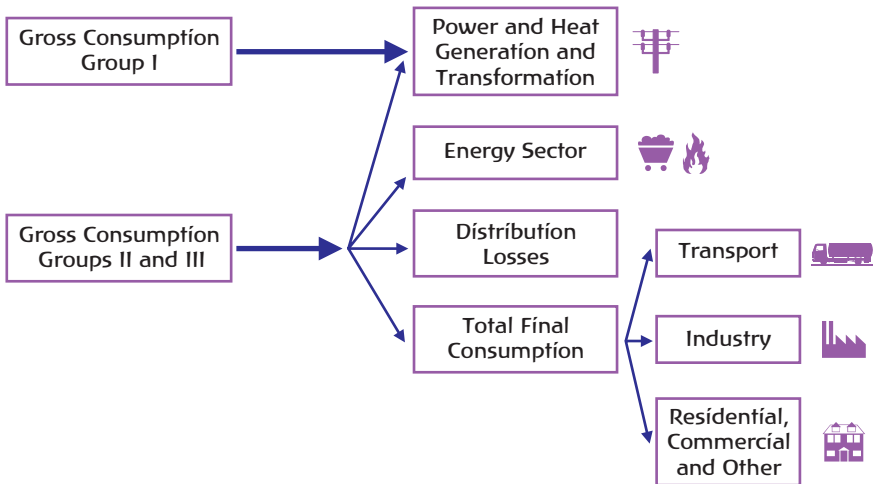

Consumption of renewables and waste in the transformation sector.....

General information

Transformation involves the use of a primary fuel product to create or generate a secondary energy product. The most obvious example is the generation of electricity or heat with renewables and waste fuels.

Renewable fuels, mainly wood but not exclusively (coconut shells, etc.), are also used to manufacture charcoal; charcoal is produced either in proper plants or *in situ* nearby available wood in a forest. Charcoal production plants are facilities used for the destructive distillation and pyrolysis of wood or other vegetal matter to manufacture charcoal. Depending on the technology used to produce charcoal, the

efficiency can vary in a ratio of 1 to 3. The efficiency can either measure in terms of ratio of mass (tonnes of charcoal over tonnes of wood) or in terms of energy (energy content of charcoal over energy content of wood).

Specific information related to the joint questionnaire

Transformation consumption is reported on Table 2.

The Transformation Sector includes statistics of electricity and heat generation according to the type of plant (i.e. electricity-only, heat-only or combined electricity and heat) as well as the separation between types of producer (i.e. public and autoproducer). For more information on these various categories, please refer to Annex 1, Section 1.

The Transformation Sector also includes wood and vegetal matter inputs used in the manufacture of charcoal. When the inputs are not known, the statistician should estimate these inputs on the basis of reasonable input/output efficiency according to the technology used for the production.

Amounts are to be reported in terajoules, except charcoal and liquid biofuels that are to be reported in 1000 tonnes. All values have to be rounded to zero decimal places and negative values are not allowed.

Essential

Report in the transformation sector inputs of energy which are transformed into other forms of energy.

Consumption of renewables and waste in the energy sector.....

General information

The consumption of the energy sector includes "own use". This includes renewables and waste fuels that are used by the energy industry to support energy production. Some examples of this are use of charcoal to heat charcoal manufacture facilities and use of biogases to heat sewage sludge or other biogas fermentation vessels.

Amounts reported for oil refineries should not include amounts transferred to refineries for use in blending or as additives.

Specific information related to the joint questionnaire

Energy sector consumption is reported on Table 2.

Report own consumption of biogas necessary to support temperatures needed for anaerobic fermentation at biogas facilities; and own consumption of renewables and waste fuels to support operation of charcoal plants, as well, when relevant, of electricity, CHP and heat plants.

Biogases which are flared (burned rather than consumed in other sectors) should be reported in the Energy Sector, under “Not elsewhere specified.”

Amounts are to be reported in terajoules, except charcoal and liquid biofuels that are to be reported in 1000 tonnes. All values have to be rounded to zero decimal places and negative values are not allowed.

Essential

The energy sector includes energy used in support of the transformation activity.

Amounts reported for oil refineries should not include amounts transferred to refineries for use in blending or as additives.

Renewables and waste distribution losses

General information

Group II and Group III renewables and waste fuels are subject to losses during storage and transportation. For example, solid materials like wood chips, municipal waste and agricultural wastes are subject to dispersal by wind and water while being held at storage sites and/or transported. Similarly, biogas transport facilities are subject to leaking.

Specific information related to the joint questionnaire

Distribution losses are reported on Table 2.

Report all losses which occur during transport and distribution. Biogases which are vented should be reported in *Distribution Losses*. Biogases which are flared (burned rather than consumed in other sectors) should be reported in the *Energy Sector* “Not elsewhere specified”.

Amounts are to be reported in terajoules, except charcoal and liquid biofuels that are to be reported in 1000 tonnes. All values have to be rounded to zero decimal places and negative values are not allowed.

Essential

Biogases which are vented should be reported in distribution losses.

Biogases which are flared should not be reported in distribution losses but in the energy sector.

Renewables and waste final energy consumption.....

General information

Final energy consumption is all Group II and Group III renewables and waste fuels delivered to consumers in the industry, transport and other sectors. It does not include any fuels used for transformation or in the energy-producing industries. The branches of the three main sectors are discussed in Chapter 1, *Fundamentals*, Section 8.

In the industry sector, the bulk of the consumption occurs in two sub-sectors: paper pulp and print, and wood and wood products (Table 3). For instance, these two sub-sectors account for about 80% of the renewables and waste final consumption of all OECD member countries.

The consumption of renewables and waste in the transport sector is still very limited, less than 1% of the global transport consumption. However, the share of renewables in transport dramatically varies from country to country, with for instance over 15% in Brazil owing to a large methanol programme. Other use includes photovoltaic driven cars, but they are still at a prototype phase.

The largest part (over 80%) of the final consumption of renewables and waste occurs in the other sectors, mainly in residential and services. Moreover, over 90% of this consumption occurs in non-OECD countries. Biomass, and for a large part fuelwood, accounts for the largest share of this consumption. Fuelwood is mostly used for cooking, for heating and for domestic hot water.

In many countries, fuelwood is auto-collected, and therefore it is difficult to have reliable statistics on final consumption (as well as on supply). Since surveys are costly, they should be organised from time to time (every five years for instance); extrapolation, based on several elements such as population growth and urbanisation rate, should be used to obtain a proxy when surveys are not available.

Production of biomass for final consumption is even more difficult to cover since most of the wood is not marketed but auto-collected. As a first proxy, when biomass is not transformed (for instance in charcoal), production could be considered equal to consumption. However, when and where possible, it is advised to conduct both a consumption survey and a supply survey from production to sale.

To be complete, it should be added that there are several elements (such as wind for sail boats, or free heat from the sun for heating houses) which are not considered in the final consumption. Should they be considered, the overall share of renewables and waste would then be higher.

Specific information related to the joint questionnaire

Final energy consumption, or Energy End Use, is reported on Table 3.

The amounts reported include fuels used by entities to generate heat for self-use, fuels for process steam, furnaces, ovens and similar facilities. Figures reported for consumption of fuels by enterprises should exclude quantities used to generate electricity and heat sold to third parties. These amounts should be reported in the Transformation Sector on Table 2.

Amounts are to be reported in terajoules, except charcoal and liquid biofuels that are to be reported in 1000 tonnes. All values have to be rounded to zero decimal places and negative values are not allowed.

Essential

Final energy consumption does not include any fuels used for transformation or in the energy industries.

7 Additional Requirements for the Joint Questionnaire on Renewables and Waste

Technical characteristics of installations, average net calorific value, production of wood and other solid wastes

General information

The discussions on climate changes have undoubtedly stimulated the development of renewable energy in order to reduce the emissions of greenhouse gases from Annex 1 Parties to the UNFCCC; therefore, there is a strong need for better monitoring this development and consequently to strengthen the reporting and dissemination of timely and reliable information on renewables and waste. This is a major challenge since a large part of renewable energy is not commercially marketed and/or is located in remote areas.

As a consequence, there is a need to collect more specific information on some of these products in order not only to monitor their annual development but also to make comparison with other countries.

Specific information related to the joint questionnaire

The complement of information concerns some technical characteristics of three types of installations (power plants, solar collectors and liquid biofuels plants), the average net calorific values of liquid biofuels and charcoal, and the production of wood and other solid wastes.

The **technical characteristics of the installations** (electricity-generating capacity, solar collector surface, liquid biofuel plant capacity and average net calorific values for liquid biofuels and charcoal) are reported on Table 4.

Hydro pumped storage capacity should be included in the *Hydro all plants* total. In reporting detailed hydro data, pumped storage must be reported separately. Hydro capacity is further separated into three categories by size. Capacity should be assigned to a size category at the "plant" level. The detailed hydro data reported by size, plus the pumped storage capacity should sum to the figure reported for "Hydro all plants."

Capacity data reported for renewables and waste electricity generation facilities on Table 4 of the *Renewables and Waste Questionnaire* must equal the capacity reported on the annual *Electricity and Heat Questionnaire* (Table 7). Please coordinate with the staff responsible for completing this questionnaire when the capacity statistics are derived.

Calorific values for liquid biofuels and charcoal are dependent upon the types of materials used to derive these products, and the process used for derivation. The data provider, or experts in these energy sectors, should be consulted to determine these statistics.

Prior to the initiation of the annual *Renewables and Waste Questionnaire*, some renewables and waste statistics were collected on the annual *Coal Questionnaire*. These data, for **wood, wood wastes and other solid wastes** were disaggregated in more detail than on the current *Renewables and Waste Questionnaire*. In order to permit member countries to maintain the data series that were collected, Table 6 has been included for the collection of more detailed statistics on these commodities.

Wood refers to fuel firewood only. Wood produced for non-energy uses should not be reported. "Other vegetal material" refers to crops produced for energy purposes, agricultural wastes like grain hulls and tree and vine clippings, and solid animal wastes and litter. Wood waste includes such materials as sawdust and bark chips. Black liquor is a liquid medium, produced in the paper manufacturing process, containing lignin, cellulose and digester chemicals, that is "burned" to recover the chemicals and extract energy.

Technical characteristics are to be reported in MW_e for electricity-generating capacity, 1000m² for solar collectors, tonne per year (tonne/yr) for liquid biofuel plants and kilojoules per kilogramme (kJ/kg) for average net calorific values. Production of Wood/Wood Wastes/Other Solid Wastes is to be reported in net terajoules. All values have to be rounded to zero decimal places and negative values are not allowed.

Essential

Please fill up Table 4 and Table 6 according to the specific information mentioned above.

Inputs to autoproducer electricity and heat generation.....

General information

With the growing importance of the environmental debate, it has become essential to identify total consumption of fuels in each respective industry and consuming sector, so that for each sector appropriate measures can be developed to conserve energy and reduce greenhouse gas emissions.

For general information and definitions for autoproduction, please refer to Chapter 2, *Electricity & Heat*, Section 1.

Specific information related to the joint questionnaire

Inputs to autoproducer electricity and heat production are reported on Table 5a to 5c.

This table provides information on the fuel use by autoproducers of electricity and heat for sale according to their principal economic activity. The table is separated into three parts corresponding to three recognised types of generating plant; electricity-only, CHP, and heat-only. The data are used for tracking fuel inputs and electricity and heat outputs by autoproducers as part of the United Nations efforts to understand CO₂ emissions by specific sector.

In the case of CHP plants, reporting separate figures for the amounts of fuel used for the production of electricity and heat requires a method of dividing the total fuel use between the two energy outputs. The division is required even if no heat is sold because the fuel use for electricity production must be reported in the Transformation Sector. The method proposed is described in *Annex 1*, Section 1 of the *Manual* and should be followed carefully.

Please note that the totals reported in this table should equal the respective totals reported in the Transformation Sector. Also note that a similar table is included with the *Electricity and Heat Questionnaire* (Table 5). To avoid inconsistent reporting, please contact the person responsible for the completion of the electricity questionnaire in your country.

Essential

Report renewables and waste used by autoproducers as input for electricity and heat (sold) production in the respective sectors.

Energy Balances



1 Why Make Balances?

The presentation of energy statistics expressed in natural units in the form of **commodity balances** between the supply and use of the energy commodities provides a check on the completeness of the data and a simple means of assembling the main statistics of each commodity so that key data are easily obtained. However, because fuels are mainly bought for their heat-raising properties and can be converted into different fuel products, it is also helpful to present the supply and use data in energy units. The format adopted is termed the **energy balance** and allows users to see the fuel conversion efficiencies and the relative importance of the different fuel supplies in their contribution to the economy.

The energy balance is also the natural starting point for the construction of various indicators of energy consumption (for example consumption per capita or per unit of GDP) and of energy efficiency. The statistician also uses the energy balance as a high-level check on the data accuracy as apparent energy gains in conversion processes or large losses indicate data problems.

2 Commodity Balances

The commodity balance and its main parts have been largely described in Chapter 1, *Fundamentals*, Section 9, *How are Energy Data Presented?* Commodity balances should be constructed at national level for every energy commodity in use, however minor, and even if some commodities are aggregated for working purposes. They should be considered as the basic framework for the national energy statistics and a valuable accounting tool used to construct energy balances, higher aggregates and indicating the data quality through the *Statistical Difference* row.

National statisticians should pursue large statistical differences in order to establish which data are wrong or incomplete. Unfortunately, it will not always be possible to correct the data and, in this case, the statistical difference should not be changed but left to illustrate the size of the problem.

Deciding whether a statistical difference should be pursued with the reporting enterprise(s) is a matter of judgement. The percentage difference which one might consider acceptable will depend upon the magnitude of the supply of the commodity. For major supplies, like natural gas or electricity, efforts should be made to keep the statistical differences below one per cent. On the other hand, for a minor commodity like tars and oils from coke ovens, a 10% error can be tolerated.

When the commodity balances are constructed from the data reported to the statistician, it may also show a statistical difference which is zero (a “closed” balance). This apparently ideal position should be regarded with suspicion as, in almost all situations, it indicates that some other statistic in the balance has been estimated to balance the account. This usually occurs when the data come from a single reporter (for example a refinery or an iron and steel works) who has all the data making up the balance and is therefore able to adjust figures to close the balance. For information and an appreciation of the data problems encountered by the enterprise concerned, the statistician should discover what element(s) has (have) been estimated to balance the account.

3 Energy Balances

It is essential to construct energy balances from the commodity balances both to check the data further and to enable users to find important relationships in the data which are concealed in the commodity balances.

The transformation of the commodity balances to an energy balance is illustrated schematically in Figure 7.1 below.

Figure 7.1 • Energy Balance Construction



The first step is to convert the natural units in the commodity balances to the chosen energy unit by multiplying by the appropriate conversion equivalent for each of the natural units. Major international energy organisations, such as the IEA and Eurostat, use energy units of tonnes of oil equivalent for their balances, where one tonne of oil equivalent (toe) is defined to be 41.868 gigajoules (see Annex 3 for a discussion of units and conversion equivalents). Many countries use the terajoule as the unit for their national energy balance.

The reformat operation consists of arranging the converted commodity balances alongside one another, rearranging certain of the rows and introducing a sign convention in the transformation sector. There are different ways an organisation can present its energy balances depending on conventions and emphasis. For instance, the differences between the IEA and Eurostat’s format will be explained more fully at the end of this chapter.

Setting an energy value to production of primary energy

Chapter 1, *Fundamentals*, Section 3 discusses the point at which primary energy production is considered as measured for statistical purposes and how this defines

the form of the primary energy for the energy accounts. For example, the gross electricity production from hydro plants is used as the primary energy form rather than the kinetic energy of the falling water because there is no statistical benefit from pursuing the adoption of the kinetic energy as the primary energy form. It does not, however, say how the amount of energy to be attributed to the primary energy form is calculated but in this case it is natural to adopt the amount of electricity generated as the measure.

Partial substitution method

In the earlier days of energy balance methodology, a **partial substitution** method was used to value primary energy production. This gave the electricity production an energy value equal to the hypothetical amount of the fuel required to generate an identical amount of electricity in a thermal power station using combustible fuels.

The advantage of this method was to limit the variations in total national energy supply due to changes in primary electricity production in countries where a significant part of electricity production was from combustible fuels. In years of little rainfall, for example, hydro production would fall and be compensated by a corresponding amount of electricity produced from fuels which were either produced or imported for the purpose. However, because of the lower efficiency of thermal power generation (typically 36%), a far larger amount of energy in the form of fuels is required to compensate for the electricity lost from hydro plants. This imbalance was overcome by substituting for hydro production an energy value nearly three times ($1/0.36$) its physical energy content.

The principle was abandoned because it had little meaning for countries in which hydroelectricity generation was the major supply and because the actual substitution values were hard to establish as they depend on the marginal electricity production efficiencies. Partial substitution also had unreal effects on the energy balance as transformation losses appeared which had no physical basis.

Physical energy content

The principle now adopted is the “physical energy content” method in which the normal physical energy value of the primary energy form is used for the production figure. For primary electricity, this is simply the gross generation figure for the source. Care is needed when expressing the percentage contributions from the various sources of national electricity production. As there is no transformation process recognised within the balances for the production of primary electricity, the respective percentage contributions from thermal and primary electricity cannot be calculated using a “fuel input” basis. Instead, the various contributions should be calculated from the amounts of electricity generated from the power stations classified by energy source (coal, nuclear, hydro, etc.). In the case of electricity generation from primary heat (nuclear and geothermal), the heat is the primary energy form. As it can be difficult to obtain measurements of the heat flow to the turbines, an estimate of the heat input is often used.

Application of the “physical energy” content principle

Nuclear heat production

Estimation of the heat content of the steam from the reactor is used only if actual values are not available. European Union Member States report the steam generation from nuclear plant on a monthly basis to Eurostat. In these cases, no estimation is required. The non-EU countries which are members of the IEA and ECE do not, in general, have similar information and for these countries the IEA imputes the primary heat production value for nuclear plants from the gross electricity generation using a thermal efficiency of 33%. As stated in Chapter 1, *Fundamentals*, Section 8, where some of the steam direct from the reactor is used for purposes other than electricity generation, the estimated primary production value must be adjusted to include it.

Geothermal heat production

Primary heat from geothermal sources is also used in geothermal power plants and a similar back-calculation of the heat supply is used where the quantities of steam supplied to the plant are not measured. In this case, however, the thermal efficiency used is 10%. The figure is only approximate and reflects the generally lower-quality steam available from geothermal sources. It should be stressed that if data for the steam input to geothermal power plants are available, they should be used in determining geothermal heat production.

The principle of using the steam from nuclear reactors as the primary energy form for the energy statistics has an important effect on any indicators of energy supply dependence. Under the present convention, the primary nuclear heat appears as an indigenous resource. However, the majority of countries which use nuclear power import their nuclear fuel and if this fact could be taken into account, it would lead to an increase in the supply dependence on other countries.

Electricity production and use at pumped storage plants

Hydroelectricity may also be produced from water flow taken from special reservoirs filled by pumping water from a river or lake at lower levels. At pumped storage plants, electricity (taken from the national grid) is used during periods of low demand (usually at night) to pump water into reservoirs for release during times of peak electricity demand when the marginal cost of electricity generation is higher. Less electricity is produced than is used to pump the water to the higher reservoir. However, the procedure is economic when the costs avoided by not using less efficient thermal power stations to generate a similar amount of electricity exceed the cost of the pumped storage procedure.

As the electricity required to pump water is generated by using fuels recorded in indigenous production or imports elsewhere in the balance, any inclusion of

pumped storage generation with natural flow hydroelectricity would double count the energy content of the pumped storage generation in Gross Inland Consumption (Eurostat) or TPES (IEA). The pumped storage generation is therefore omitted from hydroelectricity generation in the energy balance.

The energy lost in pumping, that is, the difference between the quantity of electricity used for pumping and that generated at pumped storage plants, is included in “Consumption of the energy branch” (Eurostat) under the *Electricity Energy* column.

Heat production from heat pumps

The collection of data on the electricity used by heat pumps and the heat produced does not usually raise problems related to the definitions of the energy flows. Any data collection problems usually arise when trying to find heat pump use and establishing reporting. The representation of the electricity used and heat supplied in the energy balance is, on the other hand, a more difficult task and a simplified approach has been developed.

The energy contained in the higher temperature output from a heat pump is the sum of the heat extracted from a colder source and the electrical energy required to work the pump. The heat extracted can be estimated by subtracting the electricity use from the total energy of the output. The extracted heat is considered as “new” heat and included in the indigenous production of heat. The electricity used to operate the pump is reported as an input to a transformation process under the heading *Heat pumps*. The corresponding (transformation) heat output (equal to the electricity input) will be included in the total output from the heat pumps. In this manner the energy use of the pumps is identified and their total outputs are included in the heat supply. Note that the transformation sector heading “Heat pumps” does not appear in published balances as it is too minor to merit identification, but the electricity used and heat produced from it are part of the figures reported under *Other transformation* in the IEA balance.

Production of blast-furnace gas

Blast-furnace gas, produced during the manufacture of iron in blast furnaces, is a by-product fuel from the process and is consumed at the blast furnace, elsewhere on the manufacturing site, and sometimes sold to other enterprises. The blast furnace is not designed to be a fuel conversion device but behaves like one. In order to trace and account for the fuel and energy flows, the inputs to and outputs from a blast furnace must be divided between the transformation matrix and the energy sector. *Annex 1, Section 3*, describes the principles of blast furnace operations and provides guidance on the reporting of the production and use of fuels at blast furnaces.

The reporting of blast-furnace fuel use has recently changed. Formerly, all fuels used at blast furnaces were reported as inputs to the transformation process. The IEA then employed a model to divide the fuels between the transformation and energy sectors. This is hidden in the published summary balance formats because the inputs and outputs to blast furnaces are within the *Coal* column.

4 Differences between the Energy Balances of Eurostat and the IEA

Section 9 of Chapter 1 illustrates and discusses the differences between the **commodity balances** used by the IEA and Eurostat. The major difference is in the presentation of the production of primary and secondary fuels. The Eurostat format restricts the “production” row of the commodity balances to primary (or indigenous) production and puts the production of secondary commodities in a “transformation output” part of the balances. This has the advantage of not requiring any reformatting of the balances. In other words, the Eurostat energy balance is identical in appearance to the commodity balance but expressed in an energy unit.

The IEA commodity balance, on the other hand, has both primary and secondary production reported in the “production” row of commodity balances. This has the advantage of presenting all commodities identically without requiring the user to know that there are two locations in which production information is presented. The disadvantage is that the commodity balances need reformatting to prepare the energy balance.

The **differences in the energy balances** are illustrated in Table 7.1 and Table 7.2 using the 1999 summary energy balances for Spain. Both international organisations prepare energy balances displaying all commodities but publish only summary balances in order to keep the presentation manageable.

As noted above, the Eurostat energy balance has a format identical to that of the commodity balance with its transformation part (sometimes called “transformation matrix”) divided between inputs and outputs. All quantities are positive in the transformation matrix. Like the commodity balance, the production is limited to primary production.

The IEA energy balance places only indigenous production (primary production) in the “production” row. Production of a secondary energy commodity appears as a positive quantity in the transformation matrix against the heading for the relevant transformation industry. There is a single unified transformation matrix covering both inputs and outputs. This is achieved by giving inputs a negative sign. In the examples given for Spain, the input of crude oil (including feedstock) into *Petroleum Refineries* is –62.44 million tonnes of oil equivalent (Mtoe) and the corresponding output of all petroleum products is 62.16 Mtoe. The transformation loss is shown on the right-hand side of the matrix under the *Total* column and is the algebraic sum of the inputs and outputs. This loss figure is a useful check on the accuracy of the basic data in the commodity balances and of the conversion equivalents (mainly the calorific values) used to prepare the energy balance. Small losses of about 0.5% are acceptable for refining. If the figure is larger or is positive (a transformation gain), then data should be checked. Transformation losses for thermal electricity generation are much larger as the process of making electricity from heat is inherently inefficient.

The corresponding Eurostat figure for crude oil and feedstock used in *Refineries* is 60.95 Mtoe and the output of all products amounts to 60.50 Mtoe. In this case, the transformation loss is obtained by subtracting the two figures (0.45 Mtoe).

The two organisations also differ in their treatments of some minor aspects of their balances, one of which merits explanation here.

Each organisation's balance must transfer the figures from the column for the primary electricity produced (for example hydro) into the electricity column of the balance so that its disposal, together with all other electricity, can be accounted for according to the sectors of consumption. Once primary electricity enters a national transmission system, it becomes indistinguishable from electricity produced from all other sources. It is not usually possible to say which consumers primary electricity supplies.

The IEA transfers the primary electricity by entering it into the transformation matrix as an input with a negative sign and an identical amount is included in the total electricity production in the *Electricity* column. In the example for Spain, the hydroelectricity produced (1.97 Mtoe) in the *Hydro* column is shown as -1.97 within the transformation sector and the total electricity production of 15.30 Mtoe will contain the 1.97 Mtoe of primary electricity.

Eurostat uses the transfer row to make the same transfer. The quantity $-1\ 966$ ktoe will be shown in the *Transfer* row of the *Hydro* column and $+1\ 966$ will appear in the (interproduct) transfer row of the *Electricity* column together with any other primary electricity transferred similarly (in this case, 236 ktoe from wind plants). The transfer will then contribute to the total electricity available and its disposal will be included in the consumption figures.

Table 7.1 • Eurostat Energy Balance Table for Spain, 1999

Eurostat	(1000 toe)														
	Total all products	Hard coal	Patent fuels	Coke	Total lignite	Brown coal briquettes	Tar benzol	Crude oil	Feed-stock	Total pet products	Refinery gas	Motor spirit	Kerosene Naphtha jet fuels		
Primary production	30305	7005	-	-	1561	-	-	297	-	-	-	-	-	-	
Recovered products	83	8	-	-	-	-	-	-	-	-	-	-	-	-	
Imports	101063	12061	-	82	-	-	-	57665	876	16446	-	1381	931	436	2 160
Stock change	-1506	-385	-	10	12	-	-	480	67	-926	-	-29	130	-27	40
Exports	7653	-	-	261	-	-	-	-	-	6855	-	133	1694	257	1610
Bunkers	5823	-	-	-	-	-	-	-	-	5823	-	-	-	-	-
Gross inland consumption	117469	18 688	-	-169	1573	-	-	-58422	945	2842	-	-1220	-833	152	590
Transformation input	105468	18 314	-	459	1510	-	-	-58410	2639	5145	-	22	-	-	142
Public thermal power stations	21688	15 786	-	-	-	-	-	-	-	3379	-	-	-	-	-
Autoprod. thermal power stations	4545	45	-	-	-	-	-	-	-	1602	-	-	-	-	-
Nuclear power stations	15181	-	-	-	-	-	-	-	-	-	-	-	-	-	-
Patent fuel and briquetting plants	-	-	-	-	-	-	-	-	-	-	-	-	-	-	-
Coke-oven plants	2418	2 418	-	-	-	-	-	-	-	-	-	-	-	-	-
Blast-furnace plants	459	-	-	459	-	-	-	-	-	-	-	-	-	-	-
Gas works	164	-	-	-	-	-	-	-	-	164	-	22	-	-	142
Refineries	60949	-	-	-	-	-	-	-58410	2539	-	-	-	-	-	-
District heating plants	-	-	-	-	-	-	-	-	-	-	-	-	-	-	-
Transformation output	78574	-	-	1587	-	-	-	-	60501	1864	1743	9918	4386	3260	
Public thermal power stations	7947	-	-	-	-	-	-	-	-	-	-	-	-	-	-
Autoprod. thermal power stations	2544	-	-	-	-	-	-	-	-	-	-	-	-	-	-
Nuclear pwer stations	-	-	-	-	-	-	-	-	-	-	-	-	-	-	-
Patent fuel & briquetting plants	5080	-	-	-	-	-	-	-	-	-	-	-	-	-	-
Coke-oven plants	1959	-	-	1587	-	-	-	-	-	-	-	-	-	-	-
Blast-furnace plants	458	-	-	-	-	-	-	-	-	-	-	-	-	-	-
Gas works	30	-	-	-	-	-	-	-	-	-	-	-	-	-	-
Refineries	60501	-	-	-	-	-	-	-	60501	1864	1743	9918	4388	3260	
District heating plants	-	-	-	-	-	-	-	-	-	-	-	-	-	-	-
Exchanges and transfers, returns	258	-	-	-	-	-	-	-	1594	-1334	64	-152	117	-317	1081
Interproduct transfers	-201	-	-	-	-	-	-	-	-	-199	64	-152	117	-317	1113
Products transferred	480	-	-	-	-	-	-	-	1583	-1103	-	-	-	-	-
Returns from petrochem. industry	-1	-	-	-	-	-	-	-	30	-32	-	-	-	-	-32
Consumption of energy branch	5854	5	-	-	-	-	-	-	4288	1929	-	-	-	-	-
Distribution losses	1933	-	-	-	-	-	-	-	-	-	-	-	-	-	-
Available for final consumpt.	83046	369	-	959	63	-	-	12	0	52576	0	2788	9402	4222	4789
Final non-energy consumption	8436	-	-	-	-	-	-	-	-	8107	-	-	-	-	4493
Chemical industry	5347	-	-	-	-	-	-	-	-	5018	-	-	-	-	4493
Other sectors	3089	-	-	-	-	-	-	-	-	3089	-	-	-	-	-
Final energy consumption	74297	738	-	959	-	-	-	11	-	43862	-	2784	9393	4207	-
Industry	22369	587	-	959	-	-	-	11	-	5170	-	427	-	-	-
Iron & Steel Industry	3681	389	-	881	-	-	-	-	-	370	-	38	-	-	-
Non-ferrous metal industry	1090	4	-	41	-	-	-	-	-	140	-	11	-	-	-
Chemical industry	3224	45	-	15	-	-	-	-	-	749	-	224	-	-	-
Glass, pottery & building mat.	5279	145	-	-	-	-	-	-	-	1964	-	27	-	-	-
One-extraction industry	335	1	-	-	-	-	-	-	-	125	-	7	-	-	-
Food, drink & tobacco ind.	2282	-	-	5	-	-	-	-	-	578	-	35	-	-	-
Textile, leather & clothing ind.	1059	-	-	-	-	-	-	-	-	182	-	3	-	-	-
Paper and printing	2114	3	-	-	-	-	-	-	-	304	-	27	-	-	-
Engineering & oth. metal ind.	1683	3	-	17	-	-	-	-	-	361	-	41	-	-	-
Other industries	1616	-	-	-	-	-	-	-	-	397	-	13	-	-	-
Transport	31890	-	-	-	-	-	-	-	-	31573	-	82	9393	4198	-
Railways	792	-	-	-	-	-	-	-	-	485	-	-	-	-	-
Road transport	25307	-	-	-	-	-	-	-	-	25297	-	82	9383	-	-
Air Transport	4208	-	-	-	-	-	-	-	-	4208	-	-	11	4198	-
Inland Navigation	1584	-	-	-	-	-	-	-	-	1584	-	-	-	-	-
Households, commerc. pub.	20038	151	-	-	-	-	-	-	-	7110	-	2274	-	9	-
Households	11794	141	-	-	-	-	-	-	-	3953	-	1989	-	-	-
Agriculture	2192	-	-	-	-	-	-	-	-	1712	-	77	-	9	-
Statistical differences	312	-368	-	0	63	-	-	1	0	616	-	4	8	15	296

Table 7.1 • Eurostat Energy Balance Table for Spain, 1999 (continued)

														(1000 toe)	
Gas/diesel oil	Residual fuel oil	Other pet. products	Natural gas	Derived gas	Nuclear heat	Total renew. energy	Solar heat	Geothermal energy	Biomass energy	Wind energy	Hydro energy	Other fuels	Derived heat	Electrical energy	
-	-	-	131	-	15181	6130	28	5	3894	236	1966	-	-	-	Primary production
-	-	-	-	-	-	-	-	-	-	-	-	-	-	-	Recovered products
9819	2135	358	13903	-	-	-	-	-	-	-	-	75	-	1026	Imports
-572	-355	-57	-744	-	-	-	-	-	-	-	-	-	-	-	Stock change
737	1338	289	-	-	-	-	-	-	-	-	-	-	-	537	Exports
1159	4653	11	-	-	-	-	-	-	-	-	-	-	-	-	Bunkers
4351	-4210	-11	13289	-	15181	6130	28	5	3894	236	1966	75	-	492	Gross inland consumption
363	4618	-	2963	372	15181	501	-	-	501	-	-	75	-	-	Transformation input
222	3157	-	576	291	-	145	-	-	145	-	-	-	-	-	Public thermal power stations
140	1462	-	2387	80	-	355	-	-	355	-	-	75	-	-	Autoprod. therm. power stations
-	-	-	-	-	15181	-	-	-	-	-	-	-	-	-	Nuclear power stations
-	-	-	-	-	-	-	-	-	-	-	-	-	-	-	Patent fuel & briquetting plants
-	-	-	-	-	-	-	-	-	-	-	-	-	-	-	Coke-oven plants
-	-	-	-	-	-	-	-	-	-	-	-	-	-	-	Blast-furnace plants
-	-	-	-	-	-	-	-	-	-	-	-	-	-	-	Gas works
-	-	-	-	-	-	-	-	-	-	-	-	-	-	-	Refineries
-	-	-	-	-	-	-	-	-	-	-	-	-	-	-	District heating plants
20578	13496	1721	-	860	-	-	-	-	-	-	-	74	15552	-	Transformation output
-	-	-	-	-	-	-	-	-	-	-	-	-	-	7947	Public thermal power stations
-	-	-	-	-	-	-	-	-	-	-	-	-	-	2544	Autoprod. thermal power stations
-	-	-	-	-	-	-	-	-	-	-	-	-	-	5080	Nuclear power stations
-	-	-	-	-	-	-	-	-	-	-	-	-	-	-	Patent fuel & briquetting plants
-	-	-	-	372	-	-	-	-	-	-	-	-	-	-	Coke-oven plants
-	-	-	-	458	-	-	-	-	-	-	-	-	-	-	Blast-furnace plants
-	-	-	-	30	-	-	-	-	-	-	-	-	-	-	Gas works
20578	13496	1721	-	-	-	-	-	-	-	-	-	-	-	-	Refineries
-	-	-	-	-	-	-	-	-	-	-	-	-	-	-	District heating plants
-1497	-149	-550	-	-	-	-2203	-	-	-236	-1966	-	-	-	2202	Exchanges & transfers, returns
-1497	-149	553	-	-	-	-2203	-	-	-236	-1966	-	-	-	2202	Interproduct transfers
-	-	-1103	-	-	-	-	-	-	-	-	-	-	-	-	Products transferred
-	-	-	-	-	-	-	-	-	-	-	-	-	-	-	Returns from petrochem. industry
72	2061	114	18	226	-	-	-	-	-	-	-	-	-	1317	Consumption of energy branch
-	-	-	245	-	-	-	-	-	-	-	-	-	-	1687	Distribution losses
22998	2457	1046	10063	262	-	3426	28	5	3394	-	-	-	74	15241	Available for final consumpt.
-	-	776	322	7	-	-	-	-	-	-	-	-	-	-	Final non-energy consumption
-	-	525	322	7	-	-	-	-	1401	-	-	-	-	-	Chemical industry
-	-	251	-	-	-	-	-	-	-	-	-	-	-	-	Other sectors
22965	2468	-	9740	255	-	3426	28	-	-	-	-	-	74	15241	Final energy consumption
935	1779	-	7368	225	-	1401	-	-	13	-	-	-	74	6574	Industry
51	119	-	676	225	-	-	-	-	130	-	-	-	-	1141	Iron & Steel Industry
24	105	-	131	-	-	-	-	-	-	-	-	-	-	774	Non-ferrous metal industry
86	356	-	1461	-	-	13	-	-	507	-	-	-	23	918	Chemical industry
57	192	-	2284	-	-	130	-	-	-	-	-	-	-	756	Glass, pottery & building mat.
76	43	-	77	-	-	-	-	-	487	-	-	-	-	132	One-extraction industry
237	306	-	749	-	-	284	-	-	-	-	-	-	7	658	Food, drink & tobacco ind.
81	97	-	527	-	-	-	-	-	-	-	-	-	6	344	Textile, leather & clothing ind.
33	244	-	829	-	-	507	-	-	-	-	-	-	-	471	Paper and printing
106	115	-	559	-	-	-	-	-	-	-	-	-	-	742	Engineering & oth. metal ind.
182	202	-	76	-	-	487	-	-	-	-	-	-	38	638	Other industries
17681	220	-	10	-	-	-	-	-	-	-	-	-	-	307	Transport
485	-	-	-	-	-	-	-	-	-	-	-	-	-	307	Railways
15832	-	-	10	-	-	-	-	-	-	-	-	-	-	-	Road transport
-	-	-	-	-	-	-	-	-	-	-	-	-	-	-	Air Transport
1364	220	-	-	-	-	-	-	-	-	-	-	-	-	-	Inland Navigation
4349	469	-	2362	30	-	2025	28	5	1992	-	-	-	-	8361	Households, commerc. pub.
1874	86	-	1752	21	-	2020	28	-	1992	-	-	-	-	3907	Households
1586	60	-	81	-	-	5	-	5	-	-	-	-	-	394	Agriculture
33	-11	270	0	0	-	0	1	-	0	-	-	-	-	0	Statistical differences

Table 7.2 • IEA Energy Balance Table for Spain, 1999

Million tonnes of oil equivalent											
SUPPLY AND CONSUMPTION	Coal	Crude Oil	Petroleum Products	Gas	Nuclear	Hydro	Geotherm. Solar etc.	Combust. Renew. & Waste	Electricity	Heat	Total
Production	8.60	0.30	-	0.13	15.34	1.97	0.27	4.08e	-	-	30.70
Imports	11.30	60.01	16.85	13.90	-	-	-	-	1.03	-	103.09
Exports	-0.28	-	-7.09	-	-	-	-	-	-0.54	-	-7.90
Intl. Marine Bunkers	-	-	-5.88	-	-	-	-	-	-	-	-5.88
Stock Changes	-0.36	0.54	-0.97	-0.74	-	-	-	-	-	-	-1.54
TPES	19.26	60.85	2.91	13.29	15.34	-1.97	0.27	4.08	0.49	-	118.46
Transfers	-	-1.56	-1.52	-	-	-	-	-	-	-	0.05
Statistical Differences	-0.35	-	-0.74	-	-	-	-	-	-	-	-1.08
Electricity Plants	-16.27	-	-3.44	-0.59	-15.34	-1.97	-0.24	-0.28	15.30	-	-22.82
CHP Plants	-0.04	-	-1.58	-2.37	-	-	-	-0.75e	2.44e	0.07	-2.22
Heat Plants	-	-	-	-	-	-	-	-	-	-	-
Gas Works	-	-	-0.14e	0.03	-	-	-	-	-	-	-0.11
Petroleum Refineries	-	-62.44	62.16	-	-	-	-	-	-	-	-0.27
Coal Transformation	-1.05 e	-	-	-	-	-	-	-	-	-	-1.05
Liquifaction Plants	-	-	-	-	-	-	-	-	-	-	-
Other Transformation	-	0.03	-0.03	-	-	-	-	-	-	-	-0.00
Own Use	-0.23	-	-4.27	-0.02	-	-	-	-	-	-	-5.81
Distribution Losses	-	-	-	-0.25	-	-	-	-0.00e	-1.71	-	-1.96
TFC	1.32	0.01	53.37	10.09	-	-	0.03	3.04	15.24	0.07	83.18
INDUSTRY SECTOR	1.17	0.01	9.78	7.69	-	-	-0.00	1.02	6.57	0.07	26.33
Iron and Steel	0.89e	-	0.37	0.68	-	-	-	-	1.14	-	3.08
Chemical & Petrochemicals	0.06	0.01	5.35	1.78	-	-	-	-	0.92	0.02	8.15
of which: Feedstocks	-	-	4.60	0.43	-	-	-	-	-	-	5.03
Non-ferrous Metals	0.05	-	0.14	0.13	-	-	-	-	0.77	-	1.09
Non-metallic Minerals	0.15	-	1.94	2.28	-	-	-	0.08e	0.76	-	5.21
Transport Equipment	-	-	0.13	0.35	-	-	-	-	0.28	-	0.76
Machinery	0.02	-	0.23	0.21	-	-	-	-	0.46	-	0.93
Mining and Quarrying	0.00	-	0.13	0.08	-	-	-	-	0.13	-	0.34
Food and Tobacco	0.01	-	0.59	0.75	-	-	0.00	-	0.66	0.01	2.01
Paper, Pulp and Printing	0.00	-	0.31	0.83	-	-	-	-	0.47	-	1.61
Wood and Wood Products	-	-	0.04	0.07	-	-	-	-	0.12	-	0.23
Construction	-	-	0.11	0.00	-	-	-	-	0.11	-	0.22
Textile and Leather	-	-	0.18	0.53	-	-	-	-	0.34	0.01	1.06
Non-specified	-	-	0.25	0.01	-	-	0.00	0.94 e	0.40	0.04	1.65
TRANSPORT SECTOR	-	-	32.33	0.01	-	-	-	-	0.31	-	32.65
International Civil Aviation	-	-	2.62	-	-	-	-	-	-	-	2.62
Domestic Air Transport	-	-	1.75	-	-	-	-	-	-	-	1.75
Road	-	-	25.86	0.01	-	-	-	-	-	-	25.87
Rail	-	-	0.50	-	-	-	-	-	0.21	-	0.70
Pipeline Transport	-	-	-	-	-	-	-	-	-	-	-
Internal Navigation	-	-	1.62	-	-	-	-	-	-	-	1.62
Non-specified	-	-	-	-	-	-	-	-	0.10	-	0.10
OTHER SECTORS	0.14	-	7.28	2.39	-	-	0.03	2.02	8.36	-	20.23
Agriculture	-	-	1.75	0.08	-	-	0.00	0.00e	0.39	-	2.23
Comm. and Publ. Services	0.01	-	1.47	0.54	-	-	0.02	-	3.87	-	5.91
Residential	0.13	-	4.06	1.77	-	-	0.01	2.00e	3.91	-	11.88
Non-specified	-	-	-	-	-	-	-	0.02e	0.19	-	0.21
NON-ENERGY USE	0.01	-	3.97	-	-	-	-	-	-	-	3.97
in Industry/Transf./Energy	0.01	-	3.64	-	-	-	-	-	-	-	3.65
in Transport	-	-	0.31	-	-	-	-	-	-	-	0.31
in Other Sectors	-	-	0.02	-	-	-	-	-	-	-	0.02
Electricity Generated - GWh	75436	-	24445	19058	58852	22863	2761	2902e	-	-	206317
Electricity plants	75071	-	14541	2643	58852	22863	2761	1161	-	-	177892
CHP Plants	365	-	9904	16415	-	-	-	1741e	-	-	28425
Heat Generated - TJ	-	-	320	2205	-	-	-	576	-	-	3101
CHP plants	-	-	320	2205	-	-	-	576	-	-	3101
Heat plants	-	-	-	-	-	-	-	-	-	-	-

e: estimate

Annex 1

Fuel Conversion and Energy Production Processes



1 Electricity and Heat Generation

Plant types

The annual questionnaires classify electricity and heat generating plants into three groups: **Electricity-only plants** – which generate electricity only; **Heat-only plants** – which generate heat only; and **Combined heat and power plants (CHP)** – which generate heat and electricity in a combined process.

The most widely used technical processes for providing electricity and heat are described below in the section on *Electricity and heat production processes*.

Electricity-only plants

The majority of electricity generation without heat supply is obtained from alternators driven by turbines that are propelled by steam produced from combustible fuels (including wastes), or nuclear heat. Smaller electricity-only plants also use gas turbines or internal combustion engines.

Steam may also be obtained directly from geothermal reservoirs although geothermal steam and/or hot water may need upgrading by heating with fossil fuels to produce steam of sufficient quality (temperature and pressure) to operate the turbines.

Hydro, wind, tide and ocean power plants also use turbines to drive the alternators and are part of the electricity-only category. The kinetic energy of the medium passing through the turbine (water or wind) propels the turbine and rotates the alternator.

Heat-only plants

Heat may be supplied to consumers through a pipe network or through a boiler installed in or near a building containing the dwellings and serving only that building. In all cases, the heat is sold to the consumer with direct payment or indirect payment through accommodation charges. Where a plant is dedicated to the supply of a single building or set of buildings without use of a local or regional network, the heat supply should be excluded from the survey. This energy use will then be captured in the statistics of the supply of fuels for the boiler plant.

Most heat plants rely on simple boilers using combustible fuels or geothermal heat. In a few countries where hydroelectricity is plentiful, it may prove economic to provide steam through electrically heated boilers. Geothermal heat is used where it is available either “as extracted” or upgraded by burning fuels to “add” heat to the geothermal flow.

Combined heat and power (CHP)

Combined heat and power (also known as co-generation) units provide simultaneous supplies of electricity and heat from one or sometimes several items of generating equipment. Where two generating devices are employed, they are coupled through the heat output from the first device(s) serving as the energy for the input to the second device. When heat production from a CHP unit ceases and it produces only electricity, it becomes an “electricity-only” unit and should be reported as such.

The operating conditions under which electricity output from a CHP unit may be classified as CHP electricity are currently under review by Eurostat to ensure that only *bona fide* CHP operation is included. Therefore, statisticians can expect the definitions affecting the reporting of this activity to evolve in the near future.

CHP power plants can be divided into five types: backpressure, extraction-condensing, gas turbine heat recovery, combined cycle heat recovery and reciprocating engine power plants.

Backpressure power plant

The simplest co-generation power plant is the so-called backpressure power plant where CHP electricity is generated in a steam turbine, and backpressure exerted on the steam in the turbine maintains the temperature of the steam exiting the turbine. The steam is then used for process steam or district heat. The steam boiler supplying a backpressure turbine/heat configuration can be designed to fire solid, liquid or gaseous fuels (see Figure A1.1)

Extraction-condensing power plant

A condensing power plant often generates only electricity. However, in an extraction-condensing power plant, part of the steam is extracted from the turbine. The extracted steam is then used as process steam or to provide district heat. The steam boiler supplying an extraction-condensing turbine/heat configuration can be designed to fire solid, liquid or gaseous fuels (see Figure A1.2).

Gas turbine heat recovery power plant

In gas turbine heat recovery power plants, fossil fuel is combusted in the turbine, and hot flue gases exiting the turbine are directed through a heat recovery boiler. In most cases, natural gas, oil, or a combination of these fuels is used to fire the turbine. Gas turbines can be fired with gasified solid or liquid fuels, but an appropriate gasification facility needs to be placed in proximity to the turbine (see Figure A1.3).

Combined cycle heat recovery power plant

Recently, natural gas-fired combined cycle power plants consisting of one or more gas turbines, heat recovery boilers, and a steam turbine have become quite common.

Reciprocating engine power plant

Instead of a gas turbine, a reciprocating engine, such as a diesel engine, can be combined with a heat recovery boiler, which in some applications supplies steam to a steam turbine to generate both electricity and heat.

The most widely used technical processes for providing electricity and heat are described in the section below.

Typical Parameters for a CHP Plant

There are a number of parameters used to describe the performance of a CHP plant.

Overall efficiency is defined as the ratio of the total energy delivered by the system and the energy consumed by it.

If H_m denotes the fuel consumed by the plant and H and E denote the useful heat and electricity supplied by the plant, respectively, then the overall energy efficiency, U , is:

$$U = (H + E) / H_m$$

The *efficiency of electricity production* requires a method for estimating the amount of heat used for electricity generation. The method used is known as the "Ecabert" method.

First, the useful heat produced, H , is converted to its input equivalent by dividing it by the boiler efficiency, R_c (that is, either the efficiency of the boiler replaced by the CHP system or a conventional boiler). So:

$$H_c = H / R_c$$

Then the heat assigned to the electricity production H_e is:

$$H_e = H_m - H_c$$

That is, H_e is the remaining heat after the input equivalent of the useful heat has been subtracted.

The implied efficiency of electricity generation is therefore:

$$R_e = E / H_e$$

Note that this efficiency is dependent on the efficiency of the "substituted" boiler chosen above.

The specific consumption associated with the electricity production is:

$$C_{se} = 1 / R_e$$

The index of energy saving (S) evaluates the quantity of energy saved because a conventional power station, with efficiency R_p , has not been used to produce the electricity.

$$S = (E / R_p) - [H_m - (H / R_c)]$$

Electricity and heat production processes.....

Steam turbines

Although technology is evolving to a point where reciprocating engines and combustion turbines are used in CHP applications, steam turbine plants remain the most common type used for combined production of electricity and heat. A steam unit consists of a boiler suitable for producing super-heated steam which is passed through a steam turbine that is backpressure, condensing or combined (condensing plus extraction).

Condensing turbines

Condensing turbines are generally used in conventional “electricity-only” power plants. High-pressure, super-heated steam produced in a boiler is passed through a turbine, where it expands and cools down. The kinetic energy released by the steam expansion spins the turbine blades and the alternator, thus producing electricity. If electricity generation is to be maximised, it is desirable to achieve the lowest possible exhaust pressure and temperature. Low-temperature exhaust provides little useful energy from the steam leaving the turbine and most remaining heat is usually exhausted into cooling water or the air.

Backpressure power plants

In backpressure power plants (Figure A1.1), the purpose is not to maximise electricity production, but to satisfy heat demand of an industrial process or a district heating network. The energy content of the exhaust steam depends mainly on its pressure, and by changing the exhaust pressure it is possible to control the heat-to-power ratio of a backpressure turbine. Increasing backpressure decreases the electricity generation in favour of heat production. It is sometimes possible to extract steam from the turbine at an intermediate pressure, in which case the heat production is increased.

Figure A1.1 ● Backpressure Power Plants

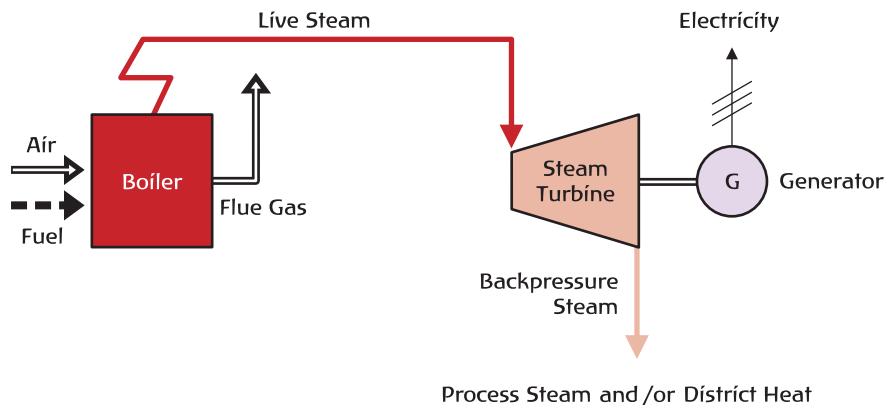

Where hot water is required, as typically in the case of urban district heating, the exhaust steam from the turbine condenses in a “hot condenser” where the heat is extracted by the water going to the district hot-water grid.

The electricity generation of a total backpressure turbine can be considered completely CHP production.

Backpressure turbines are the most common types used for CHP generation in industry. They can exploit any type of solid, gaseous and liquid fuels. Unlike internal combustion engines and gas turbines which are chosen according to the sizes available on the market, with steam turbines, custom planning is possible, within limits, for the power demand of the plant. Backpressure steam turbine units are

characterised by high thermal efficiencies, which can reach and sometimes exceed 90%. The efficiency of electricity generation is usually in the range of 15% to 25%.

Steam turbine with extraction and condensation

If the exhaust steam from a turbine is fully condensed and at low pressure, no useful heat is produced. However, steam can be extracted from the turbine at an intermediate pressure. In order to be considered functional for CHP, condensing steam turbines must have steam extraction capability. In this type of unit, part of the steam expands fully as it passes through the turbine and exits at low temperature and pressure, while a portion of the steam is extracted from the flow in the turbine at an earlier stage.

The thermal efficiency of extract-and-condense turbines is not as high as for backpressure plants because not all the energy in the exhaust steam is extracted. Some of it (10% to 20%) is lost in the condenser.

The electricity generating efficiency of condensing steam plants with heat extraction depends upon the amount of heat produced. In a completely condensing mode, when no useful heat is produced, the efficiency can be as high as 40%.

In industrial applications, extract-and-condense turbines are used where high electrical power loads are combined with a variable heat requirement. The extract-and-condense turbine is very flexible in the modulation of steam output for process and district heat. Conversely, conventional backpressure turbines are used when there is little variability of the thermal load.

Extract-and-condense turbines are generally used in large power plants. This is especially the case in northern Europe where they can generate electricity and district heat in winter and operate in a fully condensing mode in summer, producing only electricity. This electricity called “condensing power” is not considered CHP generation.

Figure A1.2 ● Steam Turbine with Extraction and Condensation

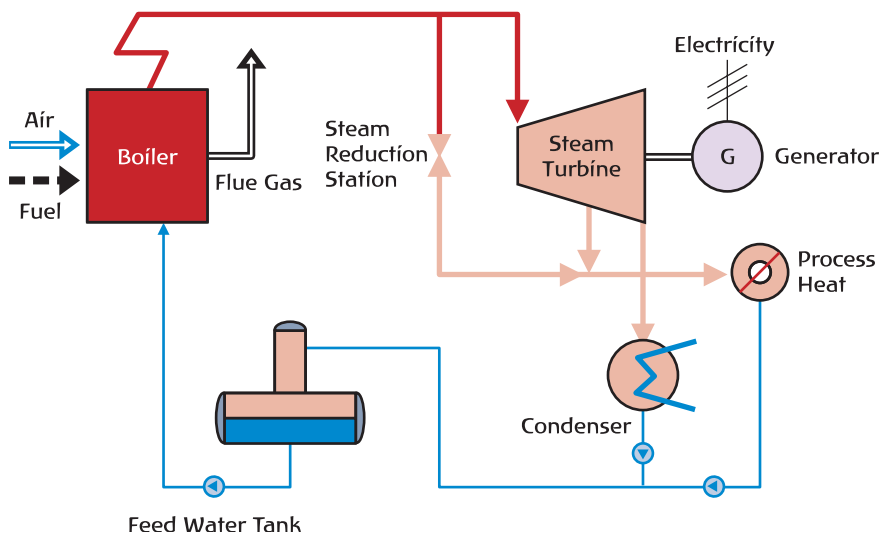

The term “condensing electricity” is sometimes used also for the electricity generation of other types of cycles, when the generation does not fulfil the definition of simultaneous exploitation of the thermal energy for electricity and heat production by co-generation. Especially in steam turbines, even if a small part of the steam is condensed, the portion of the generated electricity corresponding to the amount of wasted heat should not be considered CHP generation.

In steam power plants, backpressure or condensing type units, it is often possible to extract some steam before it passes through the turbine for heat generation. This extraction is done through a so-called steam reduction station. The heat obtained by this method is not CHP heat, since the steam is not run through the turbines and the thermal energy of the reduced steam is not used for electricity generation.

An initial comparison between the two previous types of CHP plants results in the following conclusions:

- The backpressure turbine provides ample supplies of low-cost thermal energy, but relatively less electricity; and it cannot easily adapt to major variations in the heat/power ratio.
- The extract-and-condense turbine can adapt instantly to demand for either heat or power, but at the cost of lower energy efficiency as load increases. That is, the unit cost of production rises as more steam goes to the condenser.

Gas turbine with heat recovery

Mass produced gas turbines range in size from a few hundred kW to over 100 MW. Design also ranges from “simple” turbines derived from aviation engines up to more “heavy-duty” machines with sophisticated instrumentation and turbine blade design. The more advanced the design characteristics, the higher the efficiency of the system. Combustion turbine thermal efficiency varies from 17% to 33%. Gas turbines can be used as stand-alone power generating units or they can be combined with steam units or internal combustion engines.

Gaseous or liquid fuel is injected into a chamber containing high-pressure air, where combustion occurs. The hot gas passes through the turbine as it expands, and exhaust gases are used for generating useful heat. The temperature of gas turbine exhaust gases ranges between 400°C and 600°C, making it possible to exploit recovered heat for hot water, industrial super-heated steam and steam for generating electricity in a steam turbine. The characteristics of the steam that can be produced relate directly to the temperature of the exhaust gases. Maximum guideline values are 480°C and 65 bar for direct recovery from a typical gas turbine.

Since the heat recovered from gas turbines is almost totally concentrated in its exhaust gas, thermal recovery is limited to only a single heat exchanger. Despite this operational simplicity, the exchanger must be large because of the volume of gas involved.

Because the thermal quality of the exhaust gas flow is quite high, it lends itself well to a large recovery of heat. Even with machine limits and limits of the user’s requirements, it is possible to reach total thermal efficiency ranging from 75% to 80% with gas turbine CHP systems.

Figure A1.3 • Gas Turbine with Heat Recovery

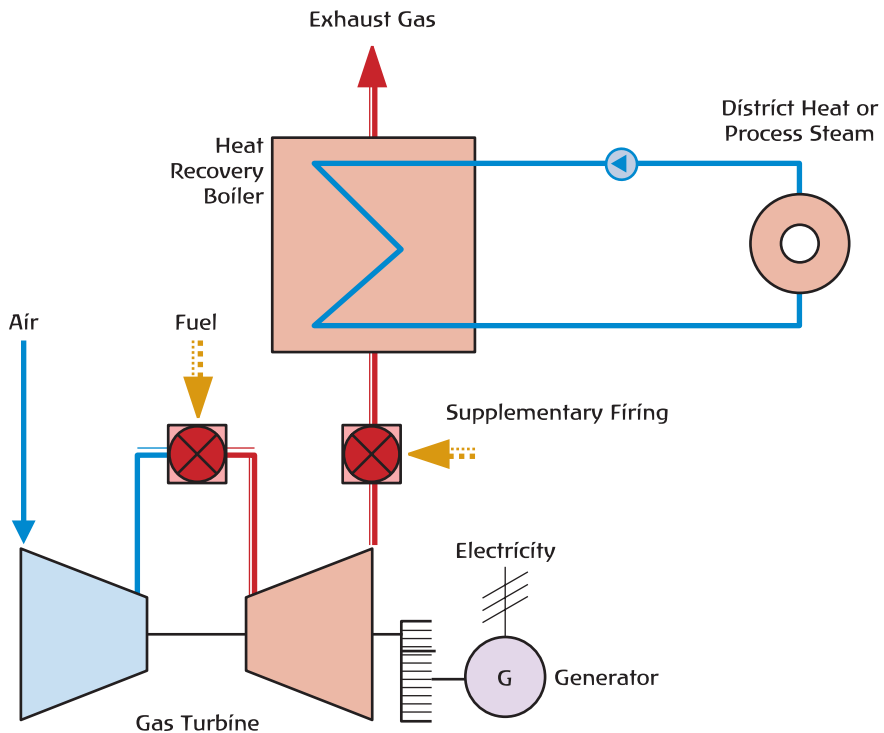

A special characteristic of the exhaust flow from gas turbines is that oxygen remains present in concentrations of 16% to 17% by weight. This permits “post-firing” – the injection of supplementary fuel into the exhaust flow (after-burn) without adding air. The result is to further upgrade thermal quality of the exhaust gas and raise heat recovery. Thermal efficiency achieved by this approach reaches close to 100% because the heat lost before the heat recovery boiler is practically zero. It should be noted, however, that heat generated by post-firing is not CHP heat, and both the input fuel and the output heat should be considered a “heat-only” system.

Gas turbines can be operated while by-passing all or part of the heat recovery system. In this case, thermal energy remaining in the exhaust gases is not used for heat production, and the electricity generation corresponding to the by-passed exhaust gases is considered “condensing power” and not CHP generation.

The efficiency of the electricity generation of a simple stand-alone gas turbine unit is typically lower than that of a condensing steam unit. However, the construction costs of a simple gas turbine power plant per kW are relatively modest, and currently only a fraction of the cost of a condensing steam unit. Thus, stand-alone gas turbine units are often used for covering the demand for electricity during peak load conditions because they can be installed economically and they can be brought on line quickly.

Reciprocating internal combustion engines

Reciprocating engines used for CHP applications range in size from a few kW (generally motor car engines) up to 20 MW. The reciprocating engines most used for co-generation fall into two clearly distinct categories:

- Diesel-cycle engines, using gasoil, or (for sizes above 800 to 1 000 kW) heavy fuel oil.
- Gas Otto-cycle engines, using fuel gas (natural gas, biogas, etc.).

The main difference is with the ignition (the Otto-cycle engines have spark ignition), in the electrical efficiency and in the heat released into the exhaust gases.

Figure A1.4 ● *Reciprocating Internal Combustion Engines*

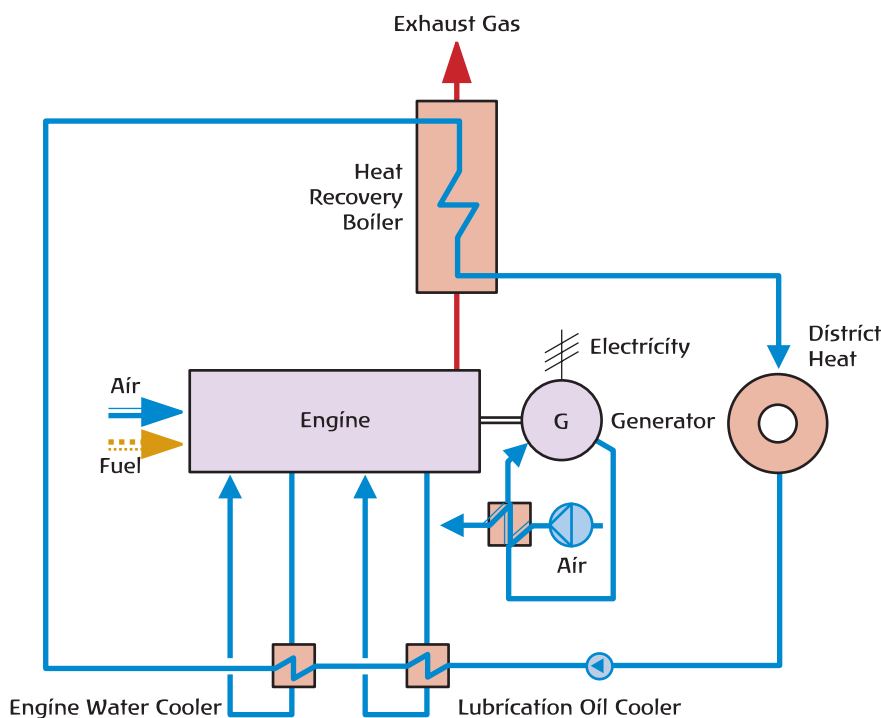

An important characteristic of diesel-cycle reciprocating engines is their high efficiency when generating electricity. This ranges from 35% to 41% for the smaller and large sizes respectively.

Heat is recovered by exploiting exhaust gas, cooling water, lubricants and, in supercharged engines, the heat available in the supercharge air.

There is a range in the quality of heat recovered in internal combustion engine systems. About 50% of the heat is recovered from engine exhaust gases, which are high-temperature and have high thermal value. Low temperatures characterise

other sources like cooling water and lubricants, which thus have low thermal value. Large and medium-sized generators can provide hot or super-heated water, and even low-pressure steam (6-7 bar). With small diesels, the average recovery is restricted to production of hot water at about 90°C.

Internal combustion engines can be combined with some other cycles, for example with steam or gas turbines, and have a variety of applications. They are popular as reserve capacity in hospitals, nuclear power stations, etc., and are also used in regular power production. Gaseous and traditional liquid fuels can be used in internal combustion engines.

Combined gas/steam cycle in co-generation

Currently, combined cycle facilities usually configure at least two types of systems one after the other so that the residual heat of the first system is exploited by the second system. In principle any combination of the cycles is possible, but the most common is a gas turbine system followed by a conventional steam system.

Figure A1.5 ● Combined Gas/Steam Cycle in Co-generation

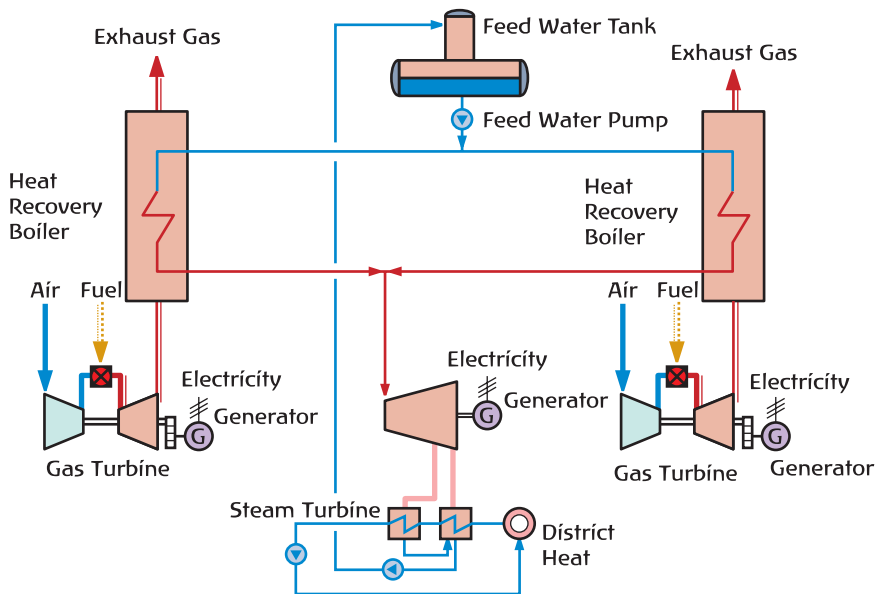

Thus, heat from the gas turbine exhaust gases supplies thermal energy to the steam system. As noted above, the heat in these gases can be upgraded by injecting additional primary energy (fuel) into the hot gases – a practice called post-firing. If the steam is a fully condensing type without heat extraction, the electricity generated by the entire system is not considered CHP production.

If, however, the steam system has heat extraction capability, the electricity generated by the gas turbine system and steam system is CHP power when heat is recovered for process or district heating. This type of plant can attain high thermal efficiency

when converting primary energy into heat and electrical energy, since there is an actual temperature change of close to 1 000°C over the entire system as compared to a change of 550°C to 600°C achieved in the most modern steam and gas turbine system when operating as electricity-only facilities.

The thermal efficiency of the electricity segment approaches, and with most recent larger units, may exceed 50%. The benefits of this system is fuller exploitation of exhaust heat which would otherwise be lost.

Recently, the combined gas/steam cycle has been adopted more widely, especially in some sectors of industry, and also in the medium range and the medium-small range power sector. The increased availability of efficient and proven gas turbines should stimulate further expansion of this technology.

Hydroelectricity production

By allowing flowing water to pass through a specially designed turbine connected to an electricity generator, the energy in the flowing water is converted to electricity.

The water may be taken from a reservoir constructed to supply the turbines. These plants are usually large generating units. Small hydro plants exploit the natural flow from rivers and are referred to as “run of river” schemes.

Pumped storage

Hydroelectricity may also be produced from water flow taken from special reservoirs filled by pumping water from a river or lake at lower levels. At pumped storage plants, electricity (taken from the national grid) is used during periods of low demand (usually at night) to pump water into reservoirs for release during times of peak electricity demand when the marginal cost of electricity generation is higher. Less electricity is produced than is used to pump the water to the higher reservoir. However, the procedure is economic when the costs avoided by not using less efficient thermal power stations to generate a similar amount of electricity exceed the cost of the pumped storage procedure. The methodology for the inclusion of pumped storage electricity generation in the energy balance is discussed in Chapter 7, Section 3.

Heat pumps

Heat pumps are devices for transferring heat from a cold source to a warmer source and may be used to draw heat from outside a building to warm the inside. They are usually driven electrically and can provide an efficient means of heating. They are not, however, in widespread use and make only a small contribution to national energy supplies.

The heat produced from a heat pump comprises the heat extracted from the colder source and the heat equivalent of the electricity used to drive the pump. In cases where the heat pump is taking heat from a natural source (for example ambient air or groundwater), the heat production consists of a mixture of primary heat and secondary heat.

2 Petroleum Product Manufacture

Refining

Crude oil and natural gas are mixtures of many different hydrocarbons and small amounts of impurities. The composition of those raw materials can vary significantly depending on their source. Petroleum refineries are complex plants where the combination and sequence of processes are usually very specific to the characteristics of the raw materials (crude oil) and the products to be produced. A refinery takes crude oil and separates it into different fractions, then converts those fractions into usable products, and these products are finally blended to produce a finished product. These products are the fuels and chemicals used every day. In a refinery, portions of the outputs from some processes are fed back into the same process, fed to new processes, fed back to a previous process or blended with other outputs to form finished products. One example of that can be seen in Figure A1.6. However, refineries are different regarding their configuration, process integration, feedstock, feedstock flexibility, products, product mix, unit size and design, and control systems.

In addition, differences in owner's strategy, market situation, location and age of the refinery, historic development, available infrastructure and environmental regulation are among other reasons for the wide variety in refinery concepts, designs and modes of operation. The environmental performance can also vary from refinery to refinery.

Figure A1.6 • Operation of a Typical Refinery

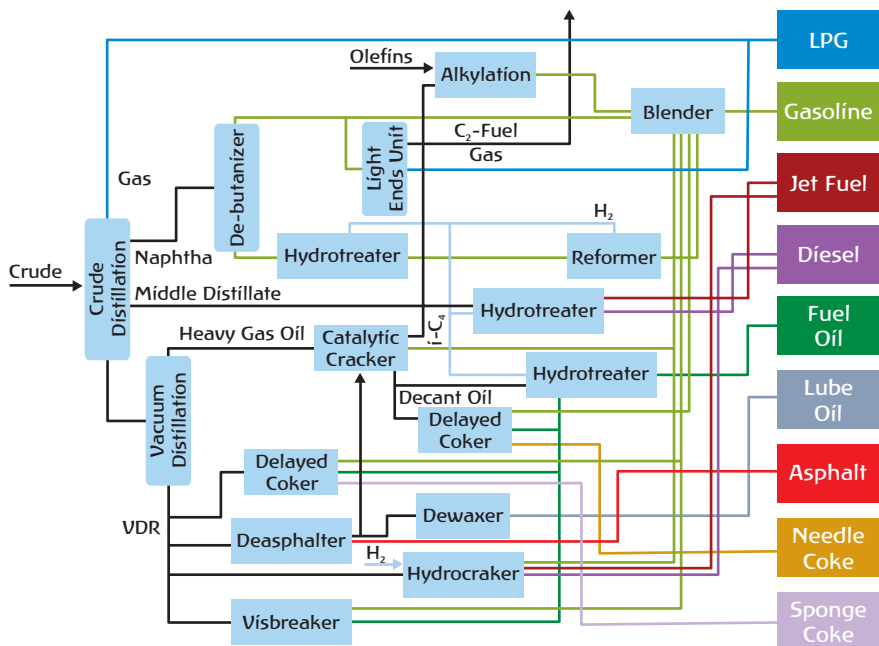

The production of a large number of fuels is by far the most important function of refineries and will generally determine the overall configuration and operation. Nevertheless, some refineries can produce valuable non-fuel products such as feedstocks for the chemical and petrochemical industries. Examples are mixed naphtha feed for a steam cracker, recovered propylene, butylene for polymer applications and aromatics manufacture. Other speciality products from a refinery include bitumen, lubricating oils, waxes and coke. In recent years the electricity boards in many countries have been liberalised, allowing refineries to feed surplus electricity generated into the public grid.

Refining crude oil into usable petroleum products can be separated into two phases and a number of supporting operations. The first phase is desalting of crude oil and the subsequent distillation into its various components or "fractions". A further distillation of the lighter components and naphtha is carried out to recover methane and ethane for use as refinery fuel, LPG (propane and butane), gasoline blending components and petrochemical feedstocks. This light product separation is done in every refinery.

The second phase is made up of three different types of "downstream" processes: combining, breaking and reshaping fractions. These processes change the molecular structure of hydrocarbon molecules either by breaking them into smaller molecules, joining them to form larger molecules, or reshaping them into higher-quality molecules. The goal of those processes is to convert some of the distillation fractions into marketable petroleum products through any combination of downstream processes. Those processes define the various refinery types, of which the simplest is the "hydroskimming", which merely desulphurises and catalytically reforms selected outputs from the distillation unit. The amounts of the various products obtained are determined almost entirely by the crude oil composition. If the product mix no longer matches the market requirements, conversion units have to be added to restore the balance.

Market demand has for many years obliged refineries to convert heavier fractions to lighter fractions with a higher value. These refineries separate the atmospheric residue into vacuum gasoil and vacuum residue fractions by distillation under high vacuum, and then feed one or both of these outputs to the appropriate conversion units. Thus, by inclusion of conversion units, the product slate can be altered to suit market requirements irrespective of the crude oil type. The number and the possible combinations of conversion units are large.

The simplest conversion unit is the thermal cracker by which the residue is subjected to such high temperatures that the large hydrocarbon molecules in the residue convert into smaller ones. Thermal crackers can handle virtually any feed, but produce relatively small quantities of light products. An improved type of thermal cracker is the coker, in which all the residue is converted into distillates and a coke product. In order to increase the degree of conversion and improve product quality, a number of different catalytic cracking processes have evolved, of which fluid catalytic cracking and hydrocracking are the most prominent. Recently, residue gasification processes have been introduced within refineries, enabling them to eliminate heavy residues completely and to convert them into clean synthetic gas for refinery use and production of hydrogen, steam and electricity via combined cycle techniques.

3 Manufacture of Coal-derived Fuels

Cokes.....

High-temperature coke

Coke is manufactured through coal pyrolysis. Coal pyrolysis means the heating of coal in an oxygen-free atmosphere to produce gases, liquids and a solid residue (char or coke). Coal pyrolysis at high temperature is called carbonisation. During carbonisation several important changes take place. Moisture is released from the coal between 100°C and 150°C. In the temperature range of 400°C to 500°C, much of the volatile matter is released as gas. From 600°C to 1 300°C, very little additional loss of volatile content occurs and weight loss is small. As the coal is heated it becomes plastic and porous during the release of gases. When it solidifies it has many fissures and pores. In the process, the temperature of the gases reaches 1 150°C to 1 350°C, indirectly heating the coal up to 1 000°C to 1 200°C for 14 to 24 hours. This produces blast-furnace and foundry cokes.

Figure A1.7 ● Typical Mass Yields from Coke Ovens

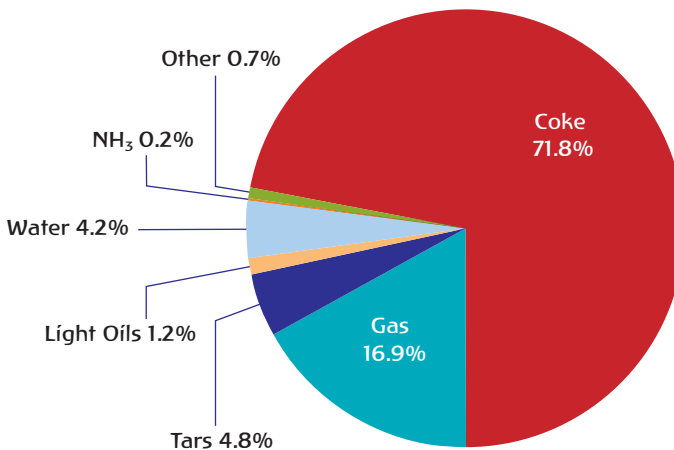

Only certain coals with the right plastic properties (for example bituminous coking or semi-soft coals) can be converted to coke. Several types of coal may be blended to improve blast furnace productivity, to extend coke battery life, etc.

The coke is made in ovens comprising a battery of individual chambers up to 60 in number. The individual coke-oven chambers are separated by heating walls. These consist of a certain number of heating flues with nozzles for fuel supply, and one or more air inlet boxes, depending on the height of the coke-oven wall. The average nozzle-brick temperature, characterising heating flue operation, is usually set between 1 150°C and 1 350°C. Usually, cleaned coke-oven gas is used as a fuel, but other gases such as blast-furnace gas enriched with natural gas, or straight natural gas can be used as well.

The carbonisation process starts immediately after coal charging. The volatile gas and moisture driven off by heating account for 8% to 11% of the charged coal. The crude coke-oven gas (COG) is exhausted through pipes into a collecting system. Because of its relatively high calorific value, the gas, after purification, is used as a fuel (e.g. for battery heating). The coal is heated by the heating/firing system and remains in the coke oven until the centre of the coal has reached a temperature of 1 000°C to 1 100°C.

Blast-furnace coke must meet certain size and strength requirements which make it suitable to support a charge of iron oxide ore and fluxes (limestone or lime) in a blast furnace. It provides heat and carbon for the reduction of the iron ore.

Foundry coke is most often used in melting and casting iron and other metals.

After cooling and handling, cokes are screened (sieved) to obtain the sizes required for their subsequent use. Small fragments of coke removed in the process are called coke breeze and are often used in the sinter plants at iron and steel works. Sintering is a process whereby iron ore fines are heated in a mixture of fluxes in order to agglomerate the particles into larger-sized pieces.

Coke-oven products

Coke ovens produce coke and untreated coke-oven gas. The gas is “purified” by removing dust particles and other valuable products. The products include tars, light oils (mostly benzene, toluene and xylene), ammonia and sulphur. Coke-oven gas is a high-quality fuel rich in hydrogen (40% to 60% by volume), and methane (30% to 40% by volume).

The actual yields of products from a coke oven depend on the coals charged and the length of the heating period. However, typical figures are illustrated in Figure A1.7 and represent the outputs expressed as percentages of coal input by mass.

Low-temperature cokes (semi-cokes)

The agglomerated residues from coal which is carbonised at temperatures below about 850°C are called low-temperature cokes. They usually have some residual volatile content and are mainly used as solid smokeless fuels (see patent fuels and briquettes below).

Patent fuels and briquettes

Patent fuels

Manufactured solid fuels are generally reported as two separate types of products. One is patent fuel. It is nominally a smokeless fuel and is derived from fines, or residual dust of hard coal. This finely divided coal is pressed into a briquette with or without a binding agent. Sometimes the binding agents are other fuels like petroleum or agglomerating renewable products like pitch. In addition, the process may involve low-temperature heating or carbonisation of the briquette during its forming. A number of patent fuels are also low-temperature cokes.

BKB or brown coal and peat briquettes

Briquettes are also manufactured from brown coal or peat. These are referred to as “brown coal briquettes” or BKB (from the German *Braunkohlenbriketts*), and may be manufactured with or without a binding agent. Brown coal and peat briquettes manufactures often rely on the residual moisture of the fuel to fuse the particles at high pressure.

In general, patent fuels have net calorific values which are similar to but slightly higher than the fuel from which they are derived. In some cases, this is due to the addition of binders (when needed) but is mostly the result of removing impurities and moisture from the finely divided particles existing before processing into briquettes. When the inputs for manufacturing these fuels are reported, it is important to include the binders (if they are energy products) and the heat and electricity used in the pressing and fusing process.

Fuel production and use in iron and steel manufacture

The iron and steel activities in some countries are limited to just the treatment and finishing of steel, without the manufacture of coke or the operation of blast furnaces. Plants which combine the coke production and iron manufacturing stages as well as the treatment and finishing of steel are known as integrated steel plants.

The manufacture of coke and the production of coke-oven gas, tars and oils have been described above. Coke is screened after production and the coke breeze is used for sinter plant operations. The coke is charged into the blast furnace.

Sinter plants

A sinter plant prepares finely divided iron ore and recycled wastes from the blast furnace and its own operations for charging into the blast furnace. Sintering is necessary because much of the iron ore now available is smaller than the ideal sizes for direct use in the blast furnace. By the addition of coke breeze and heat, the breeze will burn and help fuse together the finely divided sinter bed of materials. This fused bed of sinter is then broken into pieces and screened to select the sizes required for the blast furnace charge. Coke breeze consumed at the sinter plant is considered fuel combustion use which should be reported as consumption of the iron and steel industry.

Blast furnaces

Blast furnaces are used to manufacture iron of which the large majority is made into steel. The inputs to blast furnaces are iron oxide ore, fluxes (limestone or lime) to assist the flow of molten metal through the coke bed and remove acidities, and coke to provide heat and an open matrix structure to support the ore and fluxes and allow the molten iron to pass to the bottom of the furnace. Figure A1.8 provides an outline of the main features of a blast furnace.

The essential chemistry of the process is the reduction of iron ore (iron oxide) with carbon obtained from the coke:

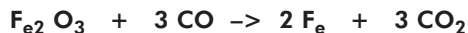

Not all of the carbon monoxide (CO) is converted to carbon dioxide (CO₂) in the process and the excess passes out of the blast furnace into the blast-furnace gas. The presence of carbon monoxide in the blast-furnace gas gives it (as produced) a heating value. The temperature of the blast air as it enters the furnace may be as high as 900°C and provides most of the heat requirement. Partial combustion of the fuels in the furnace and, where it occurs, of the fuels injected into the blast air provides the remaining heat. The blast-furnace gas is cleaned and may be enriched with coke-oven gas before use to heat the blast air and for other purposes on the manufacturing site. The blast air heaters (cowpers) are separate from the blast furnaces and not shown in Figure A1.8.

Figure A1.8 ● Key Features of a Blast Furnace

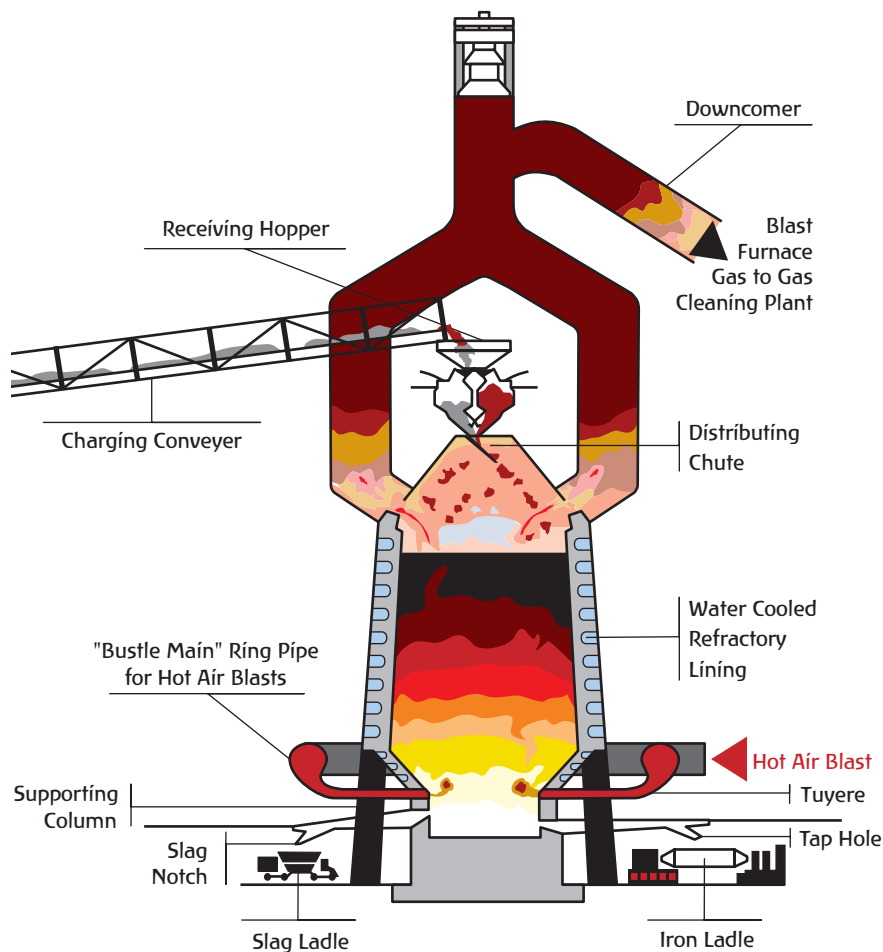

Other materials are not injected into the blast air at every plant. The purpose of injection is to provide additional carbon to the process and reduce the need for coke. Most, but not all, of the injected materials are recognised in the questionnaires as fuels. The materials partially oxidise on contact with the hot blast air, and the carbon monoxide produced, along with that from the coke, is carried up through the charge to reduce the iron oxide.

The reporting of blast-furnace fuel use is dependent on the statistics of the process as provided by the iron and steel plants. It is clear from the above, and from the discussion of coke manufacture, that integrated steel plants are large energy consumers and important parts of the energy economy. The competitive nature of the industry requires considerable efforts to reduce costs, of which energy consumption is a major part. Consequently, most enterprises keep careful accounts of fuel and energy use which are very similar to the balances described in this *Manual*. This implies that large plants, at least, should be able to report the fuels used for each process provided that the data collection formats are well matched to their internal operating returns.

Under ideal reporting conditions, statisticians would have figures for different types and quantities of fuels used at blast furnaces as well as figures for the blast-furnace gas produced. However, it is unlikely that the quantities of fuels used for blast air heating and as feedstock for the blast furnace will be separately identified. In the absence of this information, reporting should assume that all blast-furnace gas and coke-oven gas used at blast furnaces is for blast air heating and should be considered as energy sector consumption. All cokes, coals or oils should be treated as transformation use in the blast furnace. Occasionally, natural gas use may be reported but the nature of its use is less clear as it could be consumed for either purpose. If natural gas reporting occurs, the statistician should consult with the data provider.

Assuming that all data are available, this is a simple and pragmatic way to distinguish between transformation and energy sector use of the fuels.

Basic oxygen steel furnaces

Basic oxygen steel furnaces and electric arc furnaces are the primary means of steel manufacture from pig iron and steel scrap. The basic oxygen steel (BOS) furnace is of interest to the energy statistician because the process releases a gas similar in composition to blast-furnace gas and is usually collected with the latter and reported as part of blast-furnace gas production.

The BOS furnace operates with a charge of molten pig iron and some steel scrap. Oxygen is blown into the molten charge and oxidises the carbon present in the iron (about 4%) reducing it to the levels required for steel (about 0.5%). The carbon dioxide and carbon monoxide produced are carried away by the gas and dust collection system. The oxidation process heats the molten charge and helps melt the steel scrap added. In this manner, the steel scrap stabilises the temperature of the process.

Consideration of the carbon flow through the blast furnace and BOS furnace reveals that nearly all ($\approx 99.5\%$) of the carbon input to the blast furnace is carried away in the blast-furnace (including BOS) gas.

4 Natural Gas

Liquefied natural gas (LNG).....

LNG is natural gas which has been cooled to a temperature (about -160°C) at which it becomes a liquid at atmospheric pressure. It then occupies about 1/600th of the volume it occupies at normal temperatures.

Liquefying natural gas reduces the costs of gas transport over long distances and, following recent reductions in costs in the liquefaction, storage and later regasification of LNG, liquefaction has made increasingly economic the exploitation of gas sources remote from centres of demand.

Liquefaction process

The extracted gas is dried and acid components removed before liquefaction. The cooling is achieved by one or several processes in which the gas is recirculated with successive extraction of the liquid component. Heavier saleable gases (ethane, propane, etc.) and inert gases are removed during the liquefaction stage. As a result, the composition of LNG is usually richer in methane (typically 95%) than marketable natural gas which has not been liquefied.

Liquefaction is an energy-intensive process requiring electricity and heat. Both forms of energy are usually produced on site from the natural gas received by the liquefaction plant.

LNG chain and transportation

The supply chain for LNG comprises four main stages of which the first is not unique to LNG.

- Production of natural gas.
- Liquefaction and storage.
- Transport.
- Storage and regasification.

The methods for storage of LNG at the liquefaction site and the receiving terminals in destination countries are similar and comprise a "tank within a tank" design. The inner tank is usually made from nickel steel and the outer from carbon steel or prestressed concrete. The two tanks are separated by thermal insulating materials.

Transport of LNG by ship is by means of specialised double-hulled vessels carrying insulated tanks. The most common ship design uses spherical storage tanks parts of which are clearly visible above the decks.

The ship may use gas as well as oil as a fuel for its propulsion.

During storage and transport, LNG is kept at atmospheric pressure.

LNG is discharged from the ship into storage tanks at its destination in preparation for its use. The liquid is regasified by passing through pipes which are heated directly by combustion or indirectly by heated liquids. The gas is injected into the natural gas transmission system for final use. LNG may be used to satisfy part of

the baseload demand or for rapid delivery in “peak shaving” when demand on the gas network is high. Its relatively simple storage is particularly useful where the natural geological formations in a region of high gas demand do not permit storage of natural gas underground.

Compressed natural gas

Compressed natural gas (CNG) is used increasingly as a clean fuel for road transport vehicles. Natural gas is compressed to a high pressure (typically 220 atmospheres) and stored in specially designed containers for use in the vehicles. The design and inspection of the containers are rigorous as they must withstand not only the high pressure but accident damage and fire. The costs of installation and inspection of CNG containers in smaller road vehicles is rarely economic when compared with conventional fuels. However, CNG use is often economic in public transport vehicles.

There are plans for the transport of CNG by ship. Despite the difficult design problems the high-pressure storage presents, such transport would permit the exploitation of “stranded” sources of natural gas which are too small to be economically exploited through liquefaction of the gas.

A CNG vessel also has the advantage that it can discharge its cargo almost directly into the natural gas network at the destination. Unlike LNG, no storage tanks are necessary.

Storage of natural gas

Stocks of natural gas play an essential part in satisfying demand when demand or supply changes rapidly. The demand for gas increases dramatically during cold weather and it is far more economic to meet some of the demand from storage sites than to build production and transmission systems to meet peak demand. Gas storage is increasingly used as a commercial instrument to hedge against sharp supply price increases during peak demand.

Gas storage facilities fall into two basic categories which define their characteristics: seasonal or peak. Seasonal storage sites, which may also serve a strategic purpose, must be able to store huge volumes of gas built up during low demand times for slow release during periods of high demand. Peak facilities store smaller quantities but must allow to inject gas quickly into to the transmission network to meet surges in demand.

Storage of natural gas in its gaseous state requires large volume enclosures and the obvious choice is in underground geological formations which have suitable characteristics. Clearly, the underground cavity must retain the natural gas stored in it but it must also make it possible to release it for use at the desired rates. There are three main types of storage in use.

Depleted oil and gas fields

These are good choices as they are naturally capable of containing the gas and have existing installations for the injection and withdrawal of the gas. They are usually the least expensive option but may not always deliver the gas at high output rates.

Aquifers

These may be used as storage reservoirs provided that they have suitable geological characteristics. The porous sedimentary layer must be overlaid by an impermeable cap rock.

Salt cavities

Cavities in salt deposits may exist naturally or be formed by injecting water and removing the brine. They are generally smaller than the reservoirs provided by depleted oil and gas fields or aquifers but offer very good withdrawal rates and are well suited for peak-shaving requirements.

The amount of gas in a cavity is divided into two parts; the "recoverable gas" and the "cushion gas".

The cushion (or base) gas is the volume which must be present to maintain pressure and operability. It cannot be withdrawn during the operating life of the cavity. It is analogous to the oil or gas in a pipeline.

The recoverable (or working) gas is the gas held in addition to the cushion gas.

Calorific values

The calorific value of a natural gas varies according to its composition, that is, the amounts it contains of the constituent gases. The composition of the gas depends on the oil or gas field from which it is extracted and its treatment before sale. Some of the gas constituents may be "inert" with no calorific value (for example carbon dioxide or nitrogen). In general, liquefied natural gas has a higher methane content than gaseous natural gas as some heavier fuel or inert gases are removed during liquefaction.

As the methane content of natural gas increases, the calorific value decreases when expressed as megajoules (MJ) per cubic metre but increases when expressed as MJ per kilogram.

It is not possible to state the calorific value of natural gas without either measuring it directly or calculating it from a gas analysis. In general, the calorific values given in the commercial contracts at the points of import, export or entry into the national grid should be used in national statistics. The averaging of several import streams of differing calorific values has been covered in the discussion of the *Natural Gas Questionnaire*.

The calorific value of natural gas is usually expressed in MJ per cubic metre measured at specific temperature and pressure conditions set as a standard by the national gas industry or as specified in the sales contract. The importance of knowing the temperature and pressure conditions under which the calorific value has been measured has been covered in the discussion of the *Natural Gas Questionnaire*. It is very unusual, in commercial gas trade, to find the calorific value of gaseous natural gas expressed in MJ per kg or gigajoule (GJ) per tonne. However, for reference, the calorific value of pure methane at 25°C is 55.52 GJ/tonne. Observed values will therefore be less than this.

In contrast, the calorific value of LNG may be expressed in MJ per cubic metre of the liquefied gas or GJ per tonne. The ratio between a cubic metre of LNG and a cubic metre of regasified LNG depends on the composition of the LNG and is about 1:600. The density of LNG is between 0.44 and 0.47 tonnes per cubic metre, also depending on composition. Calorific values for regasified LNG range from 37.6 MJ/m³ to 41.9 MJ/m³.

Annex 2

Fuel Characteristics



1 Solid Fossil Fuels and Derived Gases

Coals

There are many types of coals. They can be distinguished by their physical and chemical characteristics which determine their suitability for various uses.

Coal is mainly composed of carbon (see Table A2.1). Coal also generates volatile matter when heated to decomposition temperatures. In addition, coal contains moisture and ash-forming mineral matter. Carbon, hydrogen, nitrogen, sulphur and oxygen are present in the coal matter. The combination of these elements and the shares of volatile matter, ash and water vary considerably from coal to coal. It is the fixed carbon content and associated volatile matter of coal that control its energy value and coking properties and make it a valuable mineral on world markets. Fixed carbon content generally influences the energy content of the coal. The higher the fixed carbon content, the higher the energy content of the coal.

Table A2.1 ● A Schematic Composition of Coal

Non-coal Matter	Coal Matter
Moisture	Fixed carbon
Ash	

- *Volatile matter* is the proportion of the air-dried coal sample that is released in the form of gas during a standardised heating test. Volatile matter is a positive feature for thermal coal but can be a negative feature for coking coal.
- *Ash* is the residue remaining after complete combustion of all organic coal matter and decomposition of the mineral matter present in the coal. The higher the ash content, the lower the quality of the coal. High ash content means a lower calorific value (or energy content per tonne of coal) and increased transport costs. Most export coal is washed to reduce the ash yield (beneficiation) and ensure a consistent quality.

- *Moisture content* refers to the amount of water present in the coal. Transport costs increase directly with moisture content. Excess moisture can be removed after beneficiation in preparation plants but this also increases handling costs.
- *Sulphur content* increases operating and maintenance costs of end-users. High amounts of sulphur cause corrosion and the emission of sulphur dioxide for both steel producers and power plants. Low-sulphur coal makes installation of desulphurisation equipment to meet emission regulations unnecessary. Southern hemisphere coals generally have a low sulphur content relative to Northern hemisphere coals.

In the ranking system discussed below, higher-rank coals have lower levels of moisture and volatile matter. Higher-rank coals also tend to have higher fixed carbon content and energy content.

Other coal properties, such as grindability, vitrinite reflectance and the crucible swelling number are also important when assessing quality. Generally, higher-rank coals have better coking qualities. Coking coals are less plentiful than thermal coals and receive a higher price.

Classification of coals

As coal resources are widely distributed and traded, many national systems have been proposed for the classification of coals. The various national classification systems have proved useful for categorising each country's coal resources and comparing imported coals of similar geological age and rank. Rank measures the amount of coalification, or alteration, the mineral has undergone in its formation. Coal is subjected to consecutive and continuous stages in evolution, from lignite (brown coal), to sub-bituminous, bituminous and finally anthracite. Coal evolves through these ranks as increases in temperature and pressure decrease the water content and increase the carbon content. Sub-bituminous coal, bituminous coal and anthracite are known collectively as black coal.

Low-rank coals, such as lignite and sub-bituminous coals, are typically softer, friable materials with a dull, earthy appearance; they are characterised by high moisture levels and a low carbon content, and hence a low energy content.

Higher-rank coals are typically harder and stronger and often have a black vitreous lustre (bright coals). Increasing rank is accompanied by a rise in the carbon and energy contents and a decrease in the moisture content of the coal. Anthracite is at the top of the rank scale and has a correspondingly higher carbon and energy content and a lower level of moisture.

The development of a single simple classification of coals which is unambiguously applicable to all coals worldwide and acceptable to the international coal industry remains an unresolved challenge. The International Standards Organization (ISO) is currently attempting the development of an ISO classification system which, while simple, is based on enough key parameters to provide a useful basis for the classification of coal resources of all ranks worldwide.

Table A2.2, reproduced from Table 5.1 gives a breakdown of primary coal products and derived fuels between solid fuels and manufactured gases. All the products are defined in the *Glossary*.

Table A2.2 • Solid Primary and Derived Coal Products

PRIMARY COAL PRODUCTS	Coking coal	SOLID FOSSIL FUELS	
	Other bituminous coal and anthracite		
	Sub-bituminous coal		
	Lignite/brown coal		
	Peat		
DERIVED FUELS	Patent fuels		MANUFACTURED GASES
	Coke-oven coke		
	Gas coke		
	Briquettes		
	Gas-works gas		
	Coke-oven gas		
	Blast-furnace gas		
Oxygen steel-furnace gas			

2 Crude Oil and Products

Crude oil.....

The chemical composition of crude oil consists mainly of compounds of hydrogen and carbon, called hydrocarbons.

There are many varieties of crude oil, because crude oil contains a wide range of hydrocarbons, depending on the location where it is found. The hydrocarbons in crude oil vary from the lightest to the heaviest, and these characteristics of the individual crude oils may determine the price.

A crude oil containing many heavier hydrocarbons and fewer lighter ones is considered a heavy crude oil, while in the reverse case, one calls it a light oil. An example of a heavy crude oil is the Mexican Maya oil, whereas the Nigerian Bonny Light is considered as light. Since the composition of a crude oil is dependent on the location where it was found, the oil is usually given the name of the region or place where it comes from. Moreover one often refers to crude produced from one reservoir, field, or region as a crude stream.

Apart from hydrocarbons, crude oil when it first comes out of the ground may contain salts, some of which might be corrosive, and sulphur. Salts are removed by a process of desalting. Sulphur may also be an undesirable characteristic for processing and quality and may need to be removed. The concentration of sulphur in crude oils varies from below 0.05% to more than 5% in some crudes – generally

the higher the density of the crude oil, the greater the sulphur content. Low-sulphur crudes are often referred to as sweet crudes, while high-sulphur varieties are sour crude. Sulphur can be removed by desulphurisation.

To evaluate a crude oil, several properties are analysed:

- Relative density (see Chapter 4, Section 3) provides for an indication of light versus heavy fractions in the crude.
- Viscosity, or the oil's resistance to flowing.
- Pour point, or the lowest temperature (in °F or °C) at which a liquid remains pourable (meaning it still behaves as a fluid).
- Water content.
- Sulphur content (see above).
- Paraffin and asphaltene content (wax as percentage of mass).
- Presence of contaminants and heavy metals.

The pricing of the oil depends largely on the above properties, as they will influence the processing and product output. It is thus not only the yield which will affect the crude oil price, but also the complexity of processing that the crude needs to undergo for refining.

Natural gas liquids (NGL)

Natural gas liquids are liquid hydrocarbon mixtures, which are gaseous at reservoir temperatures and pressures, but are recoverable by condensation and absorption.

Natural gas liquids can be classified according to their vapour pressure; this is the pressure exerted by a vapour escaping from a liquid – it quantifies the tendency of molecules to enter the gaseous phase. A natural gas liquid with a low vapour pressure is a condensate; with an intermediate pressure, it is a natural gasoline, and with a high vapour pressure it is a liquid petroleum gas. Liquid petroleum gas (LPG) is thus gaseous at ambient temperature and pressure and comprises propane and butane. Natural gasoline includes pentanes plus and heavier hydrocarbons. It is liquid at ambient temperature and pressure.

Natural gas liquids include propane, butane, pentane, hexane and heptane, but not methane and ethane, since these hydrocarbons need refrigeration to be liquefied. The term is commonly abbreviated as NGL.

Other refinery inputs

Apart from crude oil and NGL, a variety of other inputs are used to produce petroleum products. Among these inputs are refinery feedstocks – unfinished oil which has passed through a refining process, synthetically produced crude oils, for example from tar sands or coal liquefaction, and other blending components, which are blended mainly to gasoline to improve fuel properties.

These other refinery inputs come from a variety of origins, and they can be qualitatively very different.

Petroleum products

The most important function of a refinery is to produce as economically as possible the petroleum products required in the market. Petroleum products are therefore a secondary form of crude oil.

The distillation process is the first refinery process that crude oil goes through, with the objective to split the crude oil into several fractions. A distillation unit heats the crude oil and the various products are obtained and recovered at different temperatures. The lighter products, LPG, naphtha and gasoline can be recovered at the lowest temperatures, whereas jet fuel, kerosene and gas/diesel oil are recuperated at middle temperatures. This is why the latter group is also called middle distillates. The heavier fractions, such as fuel oil, need very high temperatures.

Table A2.3 ● *Primary and Secondary Oil Products*

PRIMARY OIL PRODUCTS	Crude oil	
	Natural gas liquids	
	Other hydrocarbons	
SECONDARY PRODUCTS INPUTS TO REFINERY	Additives/blending components	
	Refinery feedstocks	
SECONDARY OIL PRODUCTS	Refinery gas	Transport diesel
	Ethane	Heating and other gasoil
	Liquefied petroleum gases	Res. fuel: low-sulphur content
	Naphtha	Res. fuel: high-sulphur content
	Aviation gasoline	White spirit + SBP
	Gasoline type jet fuel	Lubricants
	Unleaded gasoline	Bitumen
	Leaded gasoline	Paraffin waxes
	Kerosene type jet fuel	Petroleum coke
	Other kerosene	Other products

The various fractions of the output of a distillation unit usually need further refining, not only because the products do not have the required properties, but also because further refining will economically improve the output. The market is increasingly demanding for higher-value lighter products, and several refining processes aim at producing a higher yield of lighter products, e.g. conversion processes such as catalytic cracking.

Below are a few of the main oil product categories and their uses:

- Liquefied petroleum gases (LPG) are used for both energy and non-energy purposes. In terms of their use as a fuel for energy, they are often used in domestic or residential heating and cooking, for agricultural purposes and increasingly in the road transport sector for use in internal combustion engines. In terms of non-energy use, they serve as feedstock for petrochemical processes, such as steam cracking.
- Motor gasoline is primarily used to fuel cars and light trucks. Demand for motor gasoline has increased very rapidly over the last few decades, in line with the demand for cars. However, environmental concerns have necessitated improvements to be made to the composition of the gasoline. For example, lead which was used to boost the octane number of the gasoline has been largely eliminated in many countries, and other additives and oxygenates which improve fuel combustion are now added. Among these additives and oxygenates are butane, aromatics, alcohols and ethers. Moreover, to further reduce pollution, biofuels (e.g. methanol produced from biomass or ethanol produced from agricultural crops) are being developed to either be blended with or replace motor gasoline.
- Gas/diesel oil includes transport diesel, heating oil and other gasoil. Transport diesel oil is used to power diesel engines in buses, trucks, trains, cars and other industrial machinery. Heating oil is used to heat domestic/residential and commercial buildings, as well as industrial boilers. Gasoil is also used for power generation, although to a much smaller extent than fuel oil. The main difference between diesel and heating oil is the sulphur content of the fuel – for environmental purposes, the specification of the sulphur content for transport diesel is much lower than that of heating oil.
- Fuel oil is used by the power generation utilities to produce electricity and heat, by industrial users for process heat and by the commercial sector to provide heating fuel for their buildings. Demand for fuel oil for power generation has dropped quite rapidly over the last thirty years, as environmental concerns and the necessity to move away from oil became important. Fuel oil is also the most important fuel for international marine bunkers, to fuel the ships.

Non-energy petroleum products

Petroleum products are not exclusively used for fuel (energy) purposes, but also many products can be used as a raw material in different sectors. A few examples of petroleum products used for non-fuel purposes are:

- LPG, motor gasoline for the petrochemical industry.
- White spirit used as a solvent for paints and varnishes.
- Lubricants for engines and machinery.

- Bitumen for the construction of roads.
- Paraffin waxes for candles, polishes, matches.
- Petroleum coke for electrode manufacturing, for carbon, graphite and chemical production.

Table A2.3, reproduced from Table 4.1, gives a comprehensive list of oil products divided between primary and secondary products. All these products are defined in the *Glossary*.

3 Natural Gas

Natural gas is composed of mainly methane (CH₄), or the simplest hydrocarbon chain. It is colourless, odourless, tasteless, and is lighter than air. It is gaseous at any temperature over -107.2°C and its specific gravity of 0.6 is lower than air. The quality and composition of natural gas varies greatly depending on the reservoir, field or formation from which it is extracted. When natural gas is produced, it contains a number of other components such as CO₂, helium, hydrogen sulphide, nitrogen, water vapour and other contaminants which may be corrosive or toxic.

Before natural gas can be used commercially, it needs to undergo a process in order to remove undesirable components. However, this removal process may not eliminate all impurities, as the quantities of these included in the gas are sometimes too small.

The value of natural gas is determined by the energy content, which depends largely on the purity of the gas and on the number of carbon atoms per unit of volume. An example of a natural gas with a high calorific value is the gas from Algeria's largest gas field Hassi-R'Mel (around 42 000 kJ/m³), whereas the gas from the Groningen field in the Netherlands is of lower calorific value (around 35 000 kJ/m³).

When natural gas is cooled to a temperature below -160°C at atmospheric pressure, it condenses to a liquid called liquefied natural gas (LNG). LNG's major advantage over natural gas is that its volume is over 600 times less than gas. Moreover LNG only weighs 45% of its equivalent volume of water. The volume and weight advantage of LNG renders it feasible to store it and transport it from producing to consuming areas.

Natural gas is considered a clean fuel, because pure methane is highly flammable, it burns easily and almost completely, and it emits very little air pollutants. Moreover it is sulphur-free; there is therefore no sulphur dioxide (SO₂) produced. With respect to nitrogen oxides (NO_x) and CO₂ emissions, they are lower than with other fossil fuels.

4 Biofuels

Fuelwood.....

Fuelwood usually refers to "roundwood" which is cut into logs and may be split before use. Fuelwood in other forms is considered separately below and covers wood chips, sawdust and pelleted wood.

All wood has about 50% carbon, 44% oxygen and 6% hydrogen when measured on an ash-free and moisture-free basis. There is usually about one per cent ash in wood and this does not vary greatly from species to species. So, as it is the carbon and hydrogen content of the wood which determine the intrinsic heating value, one kilogramme of any type of wood without moisture provides approximately the same amount of heat.

Heating values or calorific values of wood are expressed in three common ways:

- a) Per kilogramme of wood.
- b) Per solid cubic metre.
- c) Per stacked cubic metre (stere).

a) is the more fundamental measure as b) and c) are related to a) through the density of the wood and the density of packing.

The presence of moisture in a kilogramme of wood has two effects on the heating value. Increasing the amount of moisture, while keeping the mass constant at one kilogramme, reduces the amount of wood fibre available and therefore the source of heat. Also, the water absorbs and carries off the heat from the fire, thus reducing the amount of heat for useful purposes. Heating values are therefore much affected by moisture content. Green, freshly cut wood has a heating value of about 8.2 MJ/kg while air-dried wood (10% to 20% moisture content) has a heating value of about 16 MJ/kg. Wood that is completely dry (oven-dried) has a heating value of about 18 MJ/kg.

Figure A2.1 ● *Calorific Values of Fuelwood*

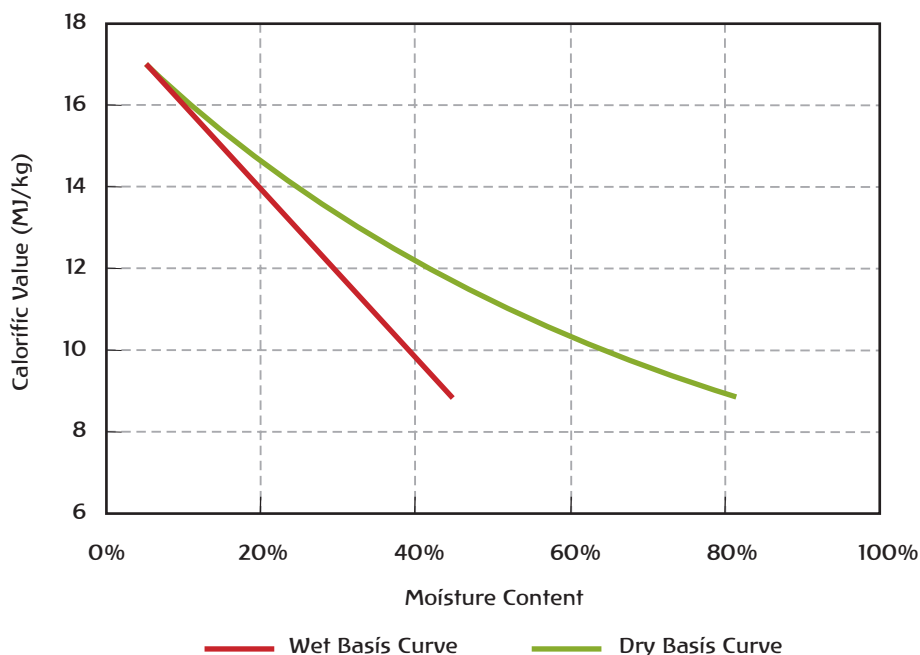

There are two ways of expressing moisture content and both are usually expressed in percentage:

- Moisture content, dry basis = wet weight minus the dry weight divided by dry weight.
- Moisture content, wet basis = wet weight minus the dry weight divided by wet weight.

Figure A2.1 gives calorific values for a range of moisture contents expressed on both bases.

Above about 15% moisture content, the difference between the two bases of measurement becomes significant. It is therefore important, when selecting a calorific value for wood, to know both the moisture content and the basis on which it has been expressed.

When heating value is to be calculated per solid cubic metre or per stère, the density of the wood must be specified as well as the moisture content.

Fuelwood in other forms and wood wastes

Wood chips and pelleted wood fuel are becoming increasingly widely used in larger boiler installations as they provide more uniform and more easily controlled combustion conditions. Wood chipping machinery may also be used to prepare wood for gasification and distribution of the gasified fuel. Pelleted fuel is manufactured from sawdust with the addition of lignin binders. It has a low moisture content at the time of manufacture ($\approx 10\%$). The moisture content and heating values for chips and pellets are usually specified by the suppliers.

Wood waste may arise in many industrial and commercial conditions and is rarely traded but used on site. The reporting enterprise may be able to state or estimate the quantity used or to state the heat obtained from it. A special case of wood waste is the production and use of black liquor.

Wastes from the residues of crops are also important sources of fuel and may be used in special plants designed to accept them, such as straw-burning boilers.

Liquid biofuels

Liquid biofuels are detailed in the *Glossary*.

Gaseous biofuels

Gaseous biofuels are detailed in the *Glossary*.

Annex 3

Units and Conversion Equivalents



1 Introduction

The most common units employed to express quantities of fuels and energy are those relating to volume, mass and energy. The actual units employed vary according to country and local conditions and reflect historical practice in the country, sometimes adapted to changing fuel supply conditions.

This annex will first describe the various units in use and their interrelationships. It will then provide reference ranges for calorific values of fuels in common use.

2 Units and their Interrelationships

The internationally recognised units which cover almost all of the measurements of fuel and energy quantities are the cubic metre, tonne (metric ton) and joule. They are derived from the metre, kilogramme and second included in the *Système International d'Unités* (SI) and serve as an international basis for science, technology and commerce. These are the SI units. However, over many years other units have been used and the sections below will list their relationships where they are well defined.

3 Decimal System Prefixes

The following table gives the most common multiple and sub-multiple prefixes used in energy statistics. Note that the prefixes should be used exactly as given. In particular, prefixes in lower case should never be written as upper case. For example, a figure expressing x kilowatts should be written as x kW, never x KW.

Table A3.1 • Most Common Multiple and Sub-multiple Prefixes

Multiple		Sub-multiple	
10 ¹	deca (da)	10 ⁻¹	deci (d)
10 ²	hecto (h)	10 ⁻²	centi (c)
10 ³	kilo (k)	10 ⁻³	milli (m)
10 ⁶	mega (M)	10 ⁻⁶	micro (μ)
10 ⁹	giga (G)	10 ⁻⁹	nano (n)
10 ¹²	tera (T)	10 ⁻¹²	pico (p)
10 ¹⁵	peta (P)	10 ⁻¹⁵	femto (f)
10 ¹⁸	exa (E)	10 ⁻¹⁸	atto (a)

4 Conversion Equivalents

Please note that a user-friendly electric unit converter for Volume, Mass and Energy is provided on the IEA web site at www.iea.org. When on the site, click on **Statistics** then click on **Unit Converter** and follow the instructions.

Units of volume

The unit of length underlies the unit of volume (metre, centimetre, etc.).

The gallon and litre were originally standards of liquid measure but are now formally defined in terms of the cubic metre.

The stère and cord are used exclusively for fuelwood measurement and represent 1 cubic metre and 128 cubic feet of stacked fuelwood, respectively. The actual volume of solid wood in each of the units is, therefore, ill-defined as the density of stacking and shape of the pieces of wood used can vary considerably.

Table A3.2 ● Conversion Equivalents between Units of Volume

To:	gal U.S.	gal U.K.	bbl	ft ³	l	m ³
From:	multiply by:					
U.S. gallon (gal)	1	0.8327	0.02381	0.1337	3.785	0.0038
U.K. gallon (gal)	1.201	1	0.02859	0.1605	4.546	0.0045
Barrel (bbl)	42.0	34.97	1	5.615	159.0	0.159
Cubic foot (ft ³)	7.48	6.229	0.1781	1	28.3	0.0283
Litre (l)	0.2642	0.220	0.0063	0.0353	1	0.001
Cubic metre (m ³)	264.2	220.0	6.289	35.3147	1 000.0	1

Units of mass

The SI unit of mass is the kilogramme (kg); the tonne (metric ton), equal to 1 000 kilogrammes, is widely used as the smallest unit in energy statistics. For most countries, the national commodity balances will use the kilotonne (1 000 tonnes) as the unit for presentation of commodities expressed in mass terms.

Table A3.3 ● Conversion Equivalents between Units of Mass

To:	kg	t	lt	st	lb
From:	multiply by:				
Kilogramme (kg)	1	0.001	9.84×10^{-4}	1.102×10^{-3}	2.2046
Tonne (t)	1000	1	0.984	1.1023	2204.6
Long ton (lt)	1016	1.016	1	1.120	2240.0
Short ton (st)	907.2	0.9072	0.893	1	2000.0
Pound (lb)	0.454	4.54×10^{-4}	4.46×10^{-4}	5.0×10^{-4}	1

Energy units

The SI unit of energy is the joule (J). Many other units for energy are in use for the practical expression of energy quantities partly for historical reasons and partly because the small size of the joule demands the use of unfamiliar (for non-scientists) decimal prefixes. As a result, the international organisations have used units for energy of a size appropriate for expressing national fuel supplies and related to the commodities in use. Historically the ton of coal equivalent was used but, with the ascendance of oil, this has been largely replaced by the tonne of oil equivalent (toe) defined as 41.868 gigajoules. Many national balances use this unit but the terajoule is increasingly used in accordance with the recommendations by the International Standards Organization (ISO).

There are several definitions of the calorie in use. The conversion equivalent between the calorie and the joule given here is the International Steam Table (IT) value which is defined to be 4.1868 joules. Similarly, the internationally agreed value for the British thermal unit (Btu) is now 1 055.06 joules. The Btu is the basis for the quad (10^{15} Btu) and the therm (10^5 Btu).

Table A3.4 ● Conversion Equivalents between Units of Energy

To:	TJ	Gcal	Mtoe	MBtu	GWh
From:	multiply by:				
Terajoule (TJ)	1	238.8	2.388×10^{-5}	947.8	0.2778
Gigacalorie	4.1868×10^{-3}	1	10^7	3.968	1.163×10^{-3}
Mtoe*	4.1868×10^{-4}	10^7	1	3.968×10^7	11630
Million Btu	1.0551×10^{-3}	0.252	2.52×10^{-8}	1	2.931×10^{-4}
Gigawatt-hour	3.6	860	8.6×10^{-5}	3412	1

*Million tonnes of oil equivalent.

5 Typical Calorific Values

Coals

Table A3.5 ● Range of Calorific Values by Hard Coal Type

Hard coals	GCV (as used) MJ/kg	NCV (as used) MJ/kg	Carbon content (as used) kg/t	Moisture content (as used) %	Carbon content (dmmf)* kg/t
Anthracite	29.65 - 30.35	28.95 - 30.35	778 - 782	10 - 12	920 - 980
Coking coals	27.80 - 30.80	26.60 - 29.80	674 - 771	7 - 9	845 - 920
Other bituminous	23.85 - 26.75	22.60 - 25.50	590 - 657	13 - 18	810 - 845

Cokes

Table A3.6 ● Calorific Values by Coke Type

Coke type	GCV (as used) MJ/kg	NCV (as used) MJ/kg	Carbon content (as used) kg/t	Moisture content % (as used)	Carbon content kg/t (dmmf)*
Metallurgical coke	27.90	27.45	820	8 - 12	965 - 970
Gas coke	28.35	27.91	853	1 - 2	856
Low-temperature coke	26.30	25.40	710	15	900
Petroleum coke (green)	30.5 - 35.8	30.0 - 35.3	875	1 - 2	890

*dmmf: dry, mineral matter-free.

Coal-derived gases.....

Table A3.7 ● Typical Calorific Values for Coal-derived Gases

Gas type	GCV (as used) MG/kg	NCV (as used) MG/kg	NCV (as used) MG/kg	Carbon content (as used) %
Coke-oven gas	19.01	16.90	37.54	464
Blast-furnace gas	2.89	2.89	2.24	179

Petroleum products.....

Table A3.8 ● Typical Calorific Values for Selected Petroleum Products

Product	Density kg/m ³	Litres per tonne	Gross calorific value (GJ/T)	Net calorific value (GJ/t) ⁽¹⁾
Ethane	366.3	2730	51.90	47.51
Propane	507.6	1970	50.32	46.33
Butane	572.7	1746	49.51	45.72
LPG ⁽²⁾	522.2	1915	50.08	46.15
Naphtha	690.6	1448	47.73	45.34
Aviation gasoline	716.8	1395	47.40	45.03
Motor gasoline ⁽³⁾	740.7	1350	47.10	44.75
Aviation turbine fuel	802.6	1246	46.23	43.92
Other kerosene	802.6	1246	46.23	43.92
Gas/diesel oil	843.9	1185	45.66	43.38
Fuel oil, low-sulphur	925.1	1081	44.40	42.18
Fuel oil, high-sulphur	963.4	1038	43.76	41.57

(1) For naphtha and heavier oils, the net calorific value is assumed to be 95% of gross.

(2) Assumes a mixture of 70% propane and 30% butane by mass.

(3) An average for motor gasolines with RON between 91 and 95.

Natural gas.....

The calorific values for methane are 55.52 MJ/kg (gross) (37.652 MJ/m³) and 50.03 MJ/kg (net) (33.939 MJ/m³). However, natural gas as supplied contains gases in addition to methane (usually ethane and propane). As the heavier gases raise the calorific value per cubic metre, the gross calorific values can vary quite widely – between 37.5 and 40.5 MJ/m³.

Table A3.9 ● Conversion Factors from Mass or Volume to Heat (Gross Calorific Value)

	LNG		GAS								
			Norway		Netherlands		Russia		Algeria		
	To:	MJ	Btu	MT	Btu	MJ	Btu	MJ	Btu	MJ	Btu
From:	multiply by:										
Cubic metre*	40.00	37912	42.51	40290	35.40	33550	37.83	35855	39.17	37125	
Kilo-gramme	54.40	51560	52.62	49870	45.19	45.19	42830	54.42	20.56	47920	

* at 15°C.

Table A3.10 ● Conversion Equivalents between Standard Cubic Metres (Scm) and Normal Cubic Metres (Ncm)

	To:	Standard cm	Normal cm
From:	multiply by:		
Standard cm*		1	0.948
Normal cm**		1.055	1

*1 Scm measured at 15°C and 760 mm Hg.

**1 Ncm measured at 0°C and 760 mm Hg.

Table A3.11 ● Conversion Equivalents between LNG and Natural Gas Units

From:	To:	Metric ton of LNG	cm of LNG	Standard cm*
	multiply by:			
Metric ton of LNG		1	0.948	1360
Cubic metre (cm) of LNG		0.45	1	615
Standard cm*		7.35×10^{-4}	1.626×10^{-3}	1

*1 Scm = 40 MJ.

Table A3.12 ● Gross versus Net Calorific Value of Natural Gas

$$1 \text{ NCV}^* = 0.9 \text{ GCV}^{**}$$

*NCV = Net Calorific Value.

**GCV = Gross Calorific Value.



1 Definitions of Fuels

Additives/oxygenates: Additives are non-hydrocarbon compounds added to or blended with a product to modify fuel properties (octane, cetane, cold properties, etc.):

- Oxygenates, such as alcohols (methanol, ethanol), ethers such as MTBE (methyl tertiary butyl ether), ETBE (ethyl tertiary butyl ether), TAME (tertiary amyl methyl ether).
- Esters (e.g. rapeseed or dimethylester, etc.).
- Chemical compounds (such as tetramethyl lead, tetraethyl lead and detergents).

Note: Quantities of ethanol reported in this category should relate to the quantities destined for fuel use.

Anthracite: See Hard coal.

Aviation gasoline: This is motor spirit prepared especially for aviation piston engines, with an octane number suited to the engine, a freezing point of -60°C and a distillation range usually within the limits of 30°C and 180°C .

Biofuels: Biofuels cover bioethanol, biodiesel, biomethanol, biodimethylether, bio-oil. Liquid biofuels are mainly biodiesel and bioethanol/ETBE used as transport fuels. They can be made from new or used vegetable oils and may be blended with or replace petroleum-based fuels. The natural plant feedstock includes soya, sunflower and oil seed rape oils. Under some circumstances, used vegetable oils may also be used as feedstock for the process.

Biogas: A gas composed principally of methane and carbon dioxide produced by anaerobic digestion of biomass, comprising:

- Landfill gas, formed by the digestion of landfilled wastes.
- Sewage sludge gas, produced from the anaerobic fermentation of sewage sludge.
- Other biogas, such as biogas produced from the anaerobic fermentation of animal slurries and of wastes in abattoirs, breweries and other agro-food industries.

Bitumen: Bitumen is a solid, semi-solid or viscous hydrocarbon with a colloidal structure, being brown to black in colour, obtained as a residue in the distillation of crude oil, by vacuum distillation of oil residues from atmospheric distillation. Bitumen is often referred to as asphalt and is primarily used for construction of roads and for roofing material. This category includes fluidised and cut back bitumen.

BKB (Braunkohlenbriketts) (includes peat briquettes): A composition fuel manufactured from lignite/brown coal. The lignite/brown coal is crushed, dried and moulded under high pressure into an even-shaped briquette without the addition of binders. German production of lignite dust is included in this category.

Black liquor: This is a recycled by-product formed during the pulping of wood in the paper making industry. In this process, lignin in the wood is separated from cellulose, with the latter forming the paper fibres. Black liquor is the combination of the lignin residue with water and the chemicals used for the extraction of the lignin and is burned in a recovery boiler. The boiler produces steam and electricity and recovers the inorganic chemicals for recycling throughout the process.

Blast-furnace gas: Obtained as a by-product in operating blast furnaces; it is recovered on leaving the furnaces and used partly within the plant and partly in other steel industry processes or in power stations equipped to burn it. The quantity of fuel should be reported on a gross calorific value.

Brown coal: See Lignite.

Charcoal: See Solid biomass.

Coke-oven coke: The solid product obtained from carbonisation of coal, principally coking coal, at high temperature; it is low in moisture and volatile matter. Coke-oven coke is used mainly in the iron and steel industry acting as energy source and chemical agent. Coke breeze and foundry coke are included in this category. Semi-coke, the solid product obtained from carbonisation of coal at low temperature, should be included in this category. Semi-coke is used as a domestic fuel or by the transformation plant itself. This heading also includes coke, coke breeze and semi-coke made from lignite/brown coal.

Coke-oven gas: Obtained as a by-product of solid fuel carbonisation and gasification operations carried out by coke producers and iron and steel plants which are not connected with gas works and municipal gas plants. The quantity of fuel should be reported on a gross calorific value.

Coking coal: See Hard coal.

Compressed natural gas (CNG): CNG is natural gas for use in special CNG vehicles, where it is stored in high-pressure fuel cylinders. CNG's use stems in part from its clean burning properties, as it produces fewer exhaust and greenhouse gas emissions than motor gasoline or diesel oil. It is used most frequently in light-duty passenger vehicles and pickup trucks, medium-duty delivery trucks, and in transit and school buses.

Crude oil: Crude oil is a mineral oil of natural origin comprising a mixture of hydrocarbons and associated impurities, such as sulphur. It exists in the liquid phase under normal surface temperature and pressure and its physical characteristics (density, viscosity, etc.) are highly variable. This category includes field or lease condensate recovered from associated and non-associated gas where it is commingled with the commercial crude oil stream.

Diesel oil: See Gas/diesel oil.

Ethane: A naturally gaseous straight-chain hydrocarbon (C_2H_6) extracted from natural gas and refinery gas streams.

Fuel oil: This covers all residual (heavy) fuel oils (including those obtained by blending). Kinematic viscosity is above 10 cSt at 80°C. The flash point is always above 50°C and density is always more than 0.90 kg/l.

- Low sulphur content: heavy fuel oil with sulphur content lower than 1%.
- High sulphur content: heavy fuel oil with sulphur content of 1% or higher.

Gas coke: A by-product of hard coal used for production of town gas in gas works. Gas coke is used for heating purposes.

Gas-works gas: Covers all types of gases including substitute natural gas produced in public utility or private plants, whose main purpose is manufacture, transport and distribution of gas. It includes gas produced by carbonisation (including gas produced by coke ovens and transferred to gas-works gas) reported under the "Production" row, by total gasification with or without enrichment with oil products (LPG, residual fuel oil, etc.), by cracking of natural gas, and by reforming and simple mixing of gases and/or air, reported under the "From other sources" row.

Gas/diesel oil (distillate fuel oil): Gas/diesel oil is primarily a medium distillate distilling between 180°C and 380°C. Several grades are available depending on uses:

- *Transport diesel:* on road diesel oil for diesel compression ignition (cars, trucks, etc.), usually of low sulphur content.
- *Heating and other gas oil:*
 - Light heating oil for industrial and commercial uses.
 - Marine diesel and diesel used in rail traffic.
 - Other gas oil including heavy gas oils which distil between 380°C and 540°C and which are used as petrochemical feedstocks.

Gasoline: See Motor gasoline or gasoline type jet fuel.

Gasoline type jet fuel (naphtha type jet fuel or JP4): This includes all light hydrocarbon oils for use in aviation turbine power units, distilling between 100°C and 250°C. It is obtained by blending kerosenes and gasoline or naphthas in such a way that the aromatic content does not exceed 25% in volume, and the vapour pressure is between 13.7kPa and 20.6kPa.

Geothermal energy: Energy available as heat emitted from within the earth's crust, usually in the form of hot water or steam. It is exploited at suitable sites:

- For electricity generation using dry steam or high enthalpy brine after flashing.
- Directly as heat for district heating, agriculture, etc.

Hard coal: Hard coal refers to coal of gross calorific value greater than 23 865 kJ/kg (5 700 kcal/kg) on an ash-free but moist basis and with a mean random reflectance of vitrinite of at least 0.6. Hard coal comprises:

(i) Coking coal: Coal with a quality that allows the production of a coke suitable to support a blast furnace charge. The following coal classification codes cover those coals which would fall in this category:

- International classification codes 323, 333, 334, 423, 433, 434, 435, 523, 533 (UN, Geneva, 1956) 534, 535, 623, 633, 634, 635, 723, 733, 823.

- USA classification Class II Group 2 “Medium Volatile Bituminous”.
- British classification Classes 202, 203, 204, 301, 302, 400, 500, 600.
- Polish classification Classes 33, 34, 35.1, 35.2, 36, 37.
- Australian classification Classes 4A, 4B, 5.

(ii) Other bituminous coal and anthracite (steam coal): Steam coal is coal used for steam raising and space heating purposes and includes all anthracite coals and bituminous coals not included under coking coal.

Hydropower: Potential and kinetic energy of water converted into electricity in hydroelectric plants. Pumped storage should be included. Detailed plant sizes should be reported **net** of pumped storage.

Kerosene type jet fuel: This is a distillate used for aviation turbine power units. It has the same distillation characteristics between 150°C and 300°C (generally not above 250°C) and flash point as kerosene. In addition, it has particular specifications (such as freezing point) which are established by the International Air Transport Association (IATA). This category includes kerosene blending components.

Leaded motor gasoline: See Motor gasoline

Lignite/brown coal: Non-agglomerating coals with a gross calorific value less than 17 435 kJ/kg (4 165 kcal/kg) and greater than 31% volatile matter on a dry mineral matter-free basis. Oil shale and tar sands produced and combusted directly should be reported in this category. Oil shale and tar sands used as inputs for other transformation processes should also be reported in this category. This includes the portion of the oil shale or tar sands consumed in the transformation process.

Liquefied natural gas (LNG): Natural gas cooled to approximately –160°C under atmospheric pressure condenses to its liquid form called LNG. LNG is odourless, colourless, non-corrosive and non-toxic.

Liquefied petroleum gases (LPG): LPG are light paraffinic hydrocarbons derived from the refinery processes, crude oil stabilisation and natural gas processing plants. They consist mainly of propane (C₃H₈) and butane (C₄H₁₀) or a combination of the two. They could also include propylene, butylene, isobutene and isobutylene. LPG are normally liquefied under pressure for transportation and storage.

Lubricants: Lubricants are hydrocarbons produced from distillate by-products; they are mainly used to reduce friction between bearing surfaces. This category includes all finished grades of lubricating oil, from spindle oil to cylinder oil, and those used in greases, including motor oils and all grades of lubricating oil base stocks.

Motor gasoline: Motor gasoline consists of a mixture of light hydrocarbons distilling between 35°C and 215°C. It is used as a fuel for land-based spark ignition engines. Motor gasoline may include additives, oxygenates and octane enhancers, including lead compounds such as TEL (Tetraethyl lead) and TML (tetramethyl lead). Motor gasoline can be divided into two groups:

- **Unleaded motor gasoline:** motor gasoline where lead compounds have not been added to enhance octane rating. It may contain traces of organic lead.

- **Leaded motor gasoline:** motor gasoline with TEL (tetraethyl lead) and/or TML (tetramethyl lead) added to enhance octane rating. This category includes motor gasoline blending components (excluding additives/oxygenates), e.g. alkylates, isomerate, reformat, cracked gasoline destined for use as finished motor gasoline.

Naphtha: Naphtha is a feedstock destined for either the petrochemical industry (e.g. ethylene manufacture or aromatics production). Naphtha comprises material in the 30°C and 210°C distillation range or part of this range. Naphtha imported for blending is reported as an import of naphtha, then shown on the *Interproduct Transfer* row, as a negative entry for naphtha, and a positive entry for the corresponding finished product.

Natural gas: It comprises gases, occurring in underground deposits, whether liquefied or gaseous, consisting mainly of methane. It includes both “non-associated” gas originating from fields producing hydrocarbons only in gaseous form, and “associated” gas produced in association with crude oil as well as methane recovered from coal mines (colliery gas).

Natural gas liquids (NGL): Natural gas liquids are liquid or liquefied hydrocarbons recovered from natural gas in separation facilities or gas processing plants. Natural gas liquids include ethane, propane, butane (normal and iso-), (iso)pentane and pentanes plus (sometimes referred to as natural gasoline or plant condensate).

The natural gas may be extracted with crude oil (associated gas) or from a gas field without crude oil. The NGL may be removed from the natural gas stream close to the well-head or transported to a distant gas processing plant. Where gas processing and crude oil production are both occurring, it is common for some of the condensate fraction of the NGL to be injected into the crude oil stream.

Oil shale: See lignite/brown coal.

Orimulsion: Emulsified oil made of water and natural bitumen.

Other bituminous coal and anthracite: See Hard coal.

Other hydrocarbons: This category includes synthetic crude oil from tar sands, shale oil, etc., liquids from coal liquefaction, output of liquids from natural gas conversion into gasoline, hydrogen and emulsified oils (e.g. orimulsion).

Other kerosene: Kerosene comprises refined petroleum distillate and is used in sectors other than aircraft transport. It distills between 150°C and 300°C.

Other petroleum products: All products not specifically mentioned above, for example tar and sulphur. This category also includes aromatics (e.g. BTX or benzene, toluene and xylene) and olefins (e.g. propylene) produced within refineries.

Oxygen steel-furnace gas: Obtained as a by-product of the production of steel in an oxygen furnace; it is recovered on leaving the furnace. The gas is also known as converter gas, BOS (basic oxygen steel) or LD gas. The quantity of fuel should be reported on a gross calorific value.

Paraffin waxes: These are saturated aliphatic hydrocarbons. These waxes are residues extracted when dewaxing lubricant oils. They have a crystalline structure which is more or less fine according to the grade. Their main characteristics are as follows: they are colourless, odourless and translucent, with a melting point above 45°C.

Patent fuel: A composition fuel manufactured from hard coal fines by shaping with the addition of a binding agent. Note that the amount of patent fuel produced can be slightly higher than the amount of coal consumed in the transformation process because of the addition of a binding agent.

Peat: Combustible soft, porous or compressed, fossil sedimentary deposit of vegetal origin with high water content (up to 90% in the raw state), easily cut, of light to dark brown colour. Only peat used for energy purposes should be reported.

Peat briquettes: see BKB.

Petroleum coke: Petroleum coke is a black solid by-product, obtained mainly by cracking and carbonising petroleum-derived feedstock, vacuum bottoms, tar and pitches in processes such as delayed coking or fluid coking. It consists mainly of carbon (90% to 95%) and has a low ash content. It is used as a feedstock in coke ovens for the steel industry, for heating purposes, for electrode manufacture and for production of chemicals. The two most important qualities are "green coke" and "calcinated coke". This category also includes "catalyst coke" deposited on the catalyst during refining processes; this coke is not recoverable and is usually burned as refinery fuel.

Refinery feedstocks: A refinery feedstock is a processed oil destined for further processing (e.g. straight run fuel oil or vacuum gas oil) excluding blending. With further processing, it will be transformed into one or more components and/or finished products. This definition also covers returns from the petrochemical industry to the refining industry (e.g. pyrolysis gasoline, C₄ fractions, gasoil and fuel oil fractions).

Refinery gas (not liquefied): Refinery gas includes a mixture of non-condensable gases mainly consisting of hydrogen, methane, ethane and olefins obtained during distillation of crude oil or treatment of oil products (e.g. cracking) in refineries. This also includes gases which are returned from the petrochemical industry.

Solar energy: Solar radiation exploited for hot water production and electricity generation, by:

- Flat plate collectors, mainly of the thermosyphon type, for domestic hot water or for the seasonal heating of swimming pools
- Photovoltaic cells.
- Solar thermal electric plants.

Note: Passive solar energy for the direct heating, cooling and lighting of dwellings or other buildings is not included.

Solid biomass: Covers organic, non-fossil material of biological origin which may be used as fuel for heat production or electricity generation. It comprises:

- **Charcoal:** Covers the solid residue of the destructive distillation and pyrolysis of wood and other vegetal material.

- **Wood, wood wastes, other solid wastes:** Covers purpose-grown energy crops (poplar, willow, etc.), a multitude of woody materials generated by an industrial process (wood/paper industry in particular) or provided directly by forestry and agriculture (firewood, wood chips, bark, sawdust, shavings, chips, black liquor, etc.) as well as wastes such as straw, rice husks, nut shells, poultry litter, crushed grape dregs, etc. Combustion is the preferred technology for these solid wastes. The quantity of fuel used should be reported on a net calorific value basis.

Steam coal: See Hard coal.

Substitute natural gas: This is a high calorific value gas, manufactured by chemical conversion of a hydrocarbon fossil fuel. It is chemically and physically interchangeable with natural gas and is usually distributed through the natural gas grid. The main raw materials for manufacture of substitute natural gas are: coal, oil and oil shales. Substitute natural gas is distinguished from other manufactured gases by its high heat value (above 8 000 kcal/m³) and by its high methane content (above 85%). Substitute natural gas produced by synthesis from fuels other than coal-based should also come under *From other sources*. The quantity of fuel should be reported on a gross calorific value.

Sub-bituminous coal: Non-agglomerating coals with a gross calorific value between 17 435 kJ/kg (4 165 kcal/kg) and 23 865 kJ/kg (5 700 kcal/kg) containing more than 31% volatile matter on a dry mineral matter-free basis.

Tar sands: see Lignite/brown coal.

Tide/wave/ocean energy: Mechanical energy derived from tidal movement or wave motion and exploited for electricity generation.

Unleaded motor gasoline: See Motor gasoline.

Wastes:

- **Industrial wastes:** Wastes of industrial non-renewable origin (solids or liquids) combusted directly for the production of electricity and/or heat. The quantity of fuel used should be reported on a net calorific value basis. Renewable industrial waste should be reported in the Solid biomass, Biogas and/or Liquid biofuels categories.
- **Municipal solid waste (renewables):** Waste produced by households, industry, hospitals and the tertiary sector which contains biodegradable materials that are incinerated at specific installations. The quantity of fuel used should be reported on a net calorific value basis.
- **Municipal solid waste (non-renewables):** Waste produced by households, industry, hospitals and the tertiary sector that contains non-biodegradable materials that are incinerated at specific installations. The quantity of fuel used should be reported on a net calorific value basis.

White spirit and specific boiling point (SBP) spirits: White spirit and SBP are defined as refined distillate intermediates with a distillation in the naphtha/kerosene range. They are subdivided as:

- **Industrial Spirit (SBP):** Light oils distilling between 30°C and 200°C. There are 7 or 8 grades of industrial spirit, depending on the position of the cut in the distillation range. The grades are defined according to the temperature difference between the 5% volume and 90% volume distillation points (which is not more than 60°C).
- **White spirit:** Industrial spirit with a flash point above 30°C. The distillation range of white spirit is 135°C to 200°C.

Wind energy: Kinetic energy of wind exploited for electricity generation in wind turbines.

Wood/wood wastes/other solid wastes: See Solid biomass.

2 List of Abbreviations

Bas	basic oxygen steel
bbl	barrel
bcm	billion cubic metres
b/d	barrels per day
Btu	British thermal unit
CCGT	combined-cycle gas turbine
CHP	combined heat and power (plant)
CNG	compressed natural gas
CO	carbon monoxide
CO ₂	carbon dioxide
COT	coke-oven gas
CV	calorific value
GCV	gross calorific value
GHG	greenhouse gas
GJ	gigajoule, or one joule x 10 ⁹ (see joule)
GJ/t	gigajoule per tonne
J	joule
kWh	kilowatt/hour, or one watt x one hour x 10 ³
LNG	liquefied natural gas
LPG	liquefied petroleum gas; refers to propane, butane and their isomers, which are gases at atmospheric pressure and normal temperature
MBtu	million British thermal units
MJ/m ³	megajoule/cubic metre
Mm ³	million cubic metres
MPP	main (public) power producer
MSW	municipal solid waste

Mtce	million tonnes of coal equivalent (1 Mtce=0.7 Mtoe)
Mtoe	million tonnes of oil equivalent
MW	megawatt, or one watt x 10 ⁶
NCV	net calorific value
Nm ³	normal cubic metre
NO _x	nitrogen oxides
PV	photovoltaic
tce	tonne of coal equivalent = 0.7 toe
TFC	total final consumption
TJ	terajoule, or one joule x 10 ¹²
toe	tonne of oil equivalent
TPES	total primary energy supply
UNFCCC	United Nations Framework Convention on Climate Change
UNIPED	International Union of Producers and Distributors of Electrical Energy (in 2002 merged with Eurelectric, and is now European Grouping of Electricity Undertakings, EEIG)
VOCs	volatile organic compounds

